



Ministry of  
Basic and  
Senior  
Secondary  
Education

Pupils' Handbook for  
Senior Secondary  
*Mathematics*

SSS

I

TERM

III



## **Foreword**

These Lesson Plans and the accompanying Pupils' Handbooks are essential educational resources for the promotion of quality education in senior secondary schools in Sierra Leone. As Minister of Basic and Senior Secondary Education, I am pleased with the professional competencies demonstrated by the writers of these educational materials in English Language and Mathematics.

The Lesson Plans give teachers the support they need to cover each element of the national curriculum, as well as prepare pupils for the West African Examinations Council's (WAEC) examinations. The practice activities in the Pupils' Handbooks are designed to support self-study by pupils, and to give them additional opportunities to learn independently. In total, we have produced 516 lesson plans and 516 practice activities – one for each lesson, in each term, in each year, for each class. The production of these materials in a matter of months is a remarkable achievement.

These plans have been written by experienced Sierra Leoneans together with international educators. They have been reviewed by officials of my Ministry to ensure that they meet the specific needs of the Sierra Leonean population. They provide step-by-step guidance for each learning outcome, using a range of recognized techniques to deliver the best teaching.

I call on all teachers and heads of schools across the country to make the best use of these materials. We are supporting our teachers through a detailed training programme designed specifically for these new lesson plans. It is really important that the Lesson Plans and Pupils' Handbooks are used, together with any other materials they may have.

This is just the start of educational transformation in Sierra Leone as pronounced by His Excellency, the President of the Republic of Sierra Leone, Brigadier Rtd Julius Maada Bio. I am committed to continue to strive for the changes that will make our country stronger and better.

I do thank our partners for their continued support. Finally, I also thank the teachers of our country for their hard work in securing our future

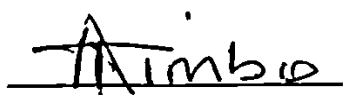

**Mr. Alpha Osman Timbo**

Minister of Basic and Senior Secondary Education

**The policy of the Ministry of Basic and Senior Secondary Education, Sierra Leone, on textbooks stipulates that every printed book should have a lifespan of three years.**

**To achieve thus, DO NOT WRITE IN THE BOOKS.**

## **Table of Contents**









<b>Lesson 97:</b> Relations and Types of Relations	3
<b>Lesson 98:</b> Mapping, Including Domain and Range	6
<b>Lesson 99:</b> Functions – Part 1	10
<b>Lesson 100:</b> Functions – Part 1	13
<b>Lesson 101:</b> Graphs of Linear Functions – Part 1	15
<b>Lesson 102:</b> Graphs of Linear Functions – Part 2	18
<b>Lesson 103:</b> Quadratic Functions	21
<b>Lesson 104:</b> Quadratic Functions on the Cartesian Plane – Part 1	24
<b>Lesson 105:</b> Quadratic Functions on the Cartesian Plane – Part 2	27
<b>Lesson 106:</b> Values from the Graphs of Quadratic Functions	30
<b>Lesson 107:</b> Factorising Quadratic Expressions	32
<b>Lesson 108:</b> Solving Quadratic Expressions	34
<b>Lesson 109:</b> Solving Quadratic Expressions using Factorisation	36
<b>Lesson 110:</b> Finding a Quadratic Equation with Given Roots	39
<b>Lesson 111:</b> Graphical Solution of Quadratic Equations	41
<b>Lesson 112:</b> Finding an Equation from a Given Graph	44
<b>Lesson 113:</b> Completing the Square and Perfect Squares	47
<b>Lesson 114:</b> The Quadratic Formula	50
<b>Lesson 115:</b> Word Problems Leading to Quadratic Equations	53
<b>Lesson 116:</b> Practice of Quadratic Equations	56
<b>Lesson 117:</b> The Degree as a Unit of Measure	59
<b>Lesson 118:</b> Acute, Obtuse, Right, Reflex, and Straight Angles	62
<b>Lesson 119:</b> Drawing of Angles with Specific Measurements	64
<b>Lesson 120:</b> Complementary and Supplementary Angles	66
<b>Lesson 121:</b> Parallel Lines	69
<b>Lesson 122:</b> Perpendicular Lines	72
<b>Lesson 123:</b> Alternate and Corresponding Angles	75
<b>Lesson 124:</b> Adjacent and Opposite Angles	78

<b>Lesson 125:</b> Interior and Exterior Angles	81
<b>Lesson 126:</b> Practical Application of Angle Measurement	84
<b>Lesson 127:</b> Word Problems Involving Angle Measurement	87
<b>Lesson 128:</b> Bisectors of Angles and Line Segments	90
<b>Lesson 129:</b> Intercept Theorem	93
<b>Lesson 130:</b> Angle Problem Solving	96
<b>Lesson 131:</b> Classification of Triangles: Equilateral, Isosceles, and Scalene	99
<b>Lesson 132:</b> Drawing of Triangles	102
<b>Lesson 133:</b> Interior and Exterior Angles of a Triangle	104
<b>Lesson 134:</b> Acute-, Obtuse-, and Right-angled Triangles	107
<b>Lesson 135:</b> Congruent and Similar Triangles	109
<b>Lesson 136:</b> Area of Triangles	112
<b>Lesson 137:</b> Word Problems Involving Triangles	115
<b>Lesson 138:</b> Finding the Hypotenuse of a Right Triangle	118
<b>Lesson 139:</b> Finding the Other Sides of a Right Triangle	121
<b>Lesson 140:</b> Application of Pythagoras' Theorem	124
<b>Answer Key:</b> Term 3	127
<b>Appendix I:</b> Protractor	146

# Introduction

## to the Pupils' Handbook

These practice activities are aligned to the Lesson Plans, and are based on the National Curriculum and the West Africa Examination Council syllabus guidelines. They meet the requirements established by the Ministry of Basic and Senior Secondary Education.

-  The practice activities will not take the whole term, so use any extra time to revise material or re-do activities where you made mistakes.
-  Use other textbooks or resources to help you learn better and practise what you have learned in the lessons.
-  Read the questions carefully before answering them. After completing the practice activities, check your answers using the answer key at the end of the book.
-  Make sure you understand the learning outcomes for the practice activities and check to see that you have achieved them. Each lesson plan shows these using the symbol to the right.
-  Organise yourself so that you have enough time to complete all of the practice activities. If there is time, quickly revise what you learned in the lesson before starting the practice activities. If it is taking you too long to complete the activities, you may need more practice on that particular topic.
-  Seek help from your teacher or your peers if you are having trouble completing the practice activities independently.
-  Make sure you write the answers in your exercise book in a clear and systematic way so that your teacher can check your work and you can refer back to it when you prepare for examinations.
-  Congratulate yourself when you get questions right! Do not worry if you do not get the right answer – ask for help and continue practising!



## **KEY TAKEAWAYS FROM SIERRA LEONE'S PERFORMANCE IN WEST AFRICAN SENIOR SCHOOL CERTIFICATE EXAMINATION – GENERAL MATHEMATICS<sup>1</sup>**

This section, seeks to outline key takeaways from assessing Sierra Leonean pupils' responses on the West African Senior School Certificate Examination. The common errors pupils make are highlighted below with the intention of giving teachers an insight into areas to focus on, to improve pupil performance on the examination. Suggestions are provided for addressing these issues.

### **Common errors**

1. Errors in applying principles of BODMAS
2. Mistakes in simplifying fractions
3. Errors in application of Maths learned in class to real-life situations, and vis-a-versa.
4. Errors in solving geometric constructions.
5. Mistakes in solving problems on circle theorems.
6. Proofs are often left out from solutions, derivations are often missing from quadratic equations.

### **Suggested solutions**

1. Practice answering questions to the detail requested
2. Practice re-reading questions to make sure all the components are answered.
3. If possible, procure as many geometry sets to practice geometry construction.
4. Check that depth and level of the lesson taught is appropriate for the grade level.

---

<sup>1</sup> This information is derived from an evaluation of WAEC Examiner Reports, as well as input from WAEC examiners and Sierra Leonean teachers.



<b>Lesson Title:</b> Relations and types of relations	<b>Theme:</b> Algebraic Processes
<b>Practice Activity:</b> PHM1-L097	<b>Class:</b> SSS 1

	<p><b>Learning Outcomes</b></p> <p>By the end of the lesson, you will be able to:</p> <ol style="list-style-type: none"> <li>1. Identify and describe relations between sets.</li> <li>2. Create arrow diagram to show relations between sets.</li> </ol>
---	---

### Overview

A **relation** is simply a connection between two sets. A relation can be represented by drawing arrows from the first set to the second set.

An **arrow diagram** is shown at right. It shows the relation between the people and the days of the week.

- The arrow shows on which day of the week each pupil washes their clothes.
- In symbols, we write  $P \rightarrow D$

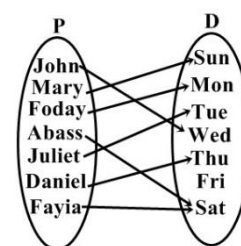

There are four types of relations and these are one-to-one, one-to-many, many-to-one and many-to-many. These relationships are described using the relationship of elements in the first set (domain) to elements in the second set (co-domain or range).

- One – to – one relation is a relation in which each element in the domain has exactly one image in the co-domain.
- One – to – many relation is a relation in which one element in the domain has many elements in the co-domain.
- Many – to – one relation is a relation in which more than one element in the domain has only one element in the co-domain.
- Many – to – Many relation is a relation in which many elements in the domain have many elements in the co-domain.

### Solved Examples

1. Draw an arrow diagram for the following relation, which describes the location of schools.

Area (A)	School (S)
Eastern	Grammar School
Central	Annie Walsh Memorial
Western	Albert Academy

**Solution:**

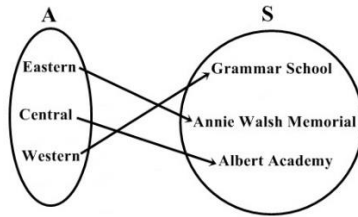

2. Ethnic tribes can be identified by the districts in Sierra Leone where they can be predominantly found.

Ethnic tribe (T)	(D) District/Region
Krio	Kono
Temne	Bo
Mende	Tonkolili
Kono	Western Area
Limba	Kenema

- Describe the relation in words.
- Draw an arrow diagram to illustrate the relation.
- Identify the type of relation.

**Solutions:**

- The relation shows some “major tribes and their regions” in Sierra Leone.
- 

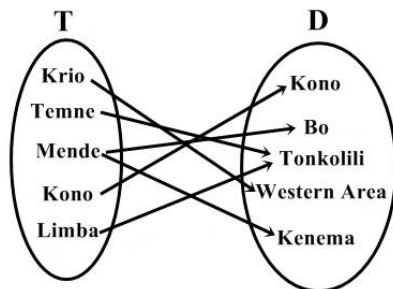

- The relation is a many-to-many relation.

3. The diagram below show the set of coordinates in the  $x, y$ - plane.

- Identify and describe the relation between the  $x$  and  $y$  coordinates.
- Write each set of elements as an ordered pair.
- Identify the type of relation between the  $x$  and  $y$  coordintes

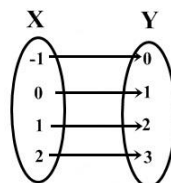

**Solutions:**

- The relation between the  $x$  and  $y$  coordinates is for every  $x$  to get  $y$ , one is added to the  $x$ , that is “one plus”.
  - The ordered pairs are:  $(-1, 0)$ ,  $(0, 1)$ ,  $(1, 2)$ ,  $(2, 3)$
  - The type of relation is a one-to-one relation.
4. If  $R = \{(-1, -3), (0, -2), (1, -1), (2, 0), (3, 1)\}$  is a relation:

- a. Write the domain and range of R.
- b. Represent R by an arrow diagram.

**Solutions:**

- a. The domain of  $R = \{-1, 0, 1, 2, 3\}$   
The range of  $R = \{-3, -2, -1, 0, 1\}$
- b.

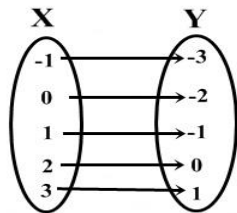

**Practice**

1. Draw an arrow diagram for the following lists:

- a. Districts and their capitals:

Bombali	Makeni
Bonthe	Bonthe
Kenema	Kenema
Koinadugugu	Kabala

- b. Perfect squares and their square roots:

1	1
4	2
9	3
16	4

2. From arrow diagram shown:

- a. Describe the relation in words.
- b. Identify the type of relation.

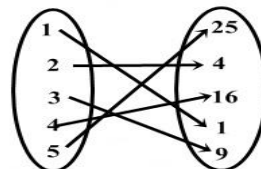

3. Identify the type of relations from the arrow diagrams below:

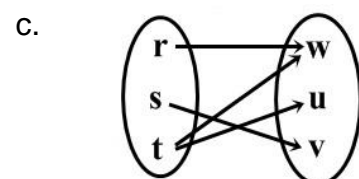
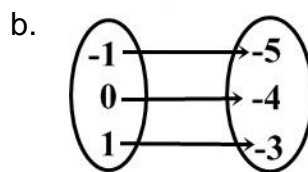
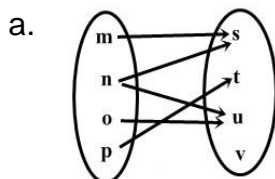

4. Draw an arrow diagram for the ordered pairs below, and identify the type of relations they represent:

- a. (1, a), (2, b), (3, c), (1, b)
- b. (Sia, Sahr), (Kumba, Tamba), (Finda, Aiah), (Bondu, Komba)

<b>Lesson Title:</b> Mapping, including domain and range	<b>Theme:</b> Algebraic Processes
<b>Practice Activity:</b> PHM1-L098	<b>Class:</b> SSS 1



### Learning Outcomes

By the end of the lesson, you will be able to:

1. Determine the rule for a given mapping.
2. Distinguish between domain and range.

### Overview

A relation between two sets can be described by a rule, given the element of the domain (elements of the first set), we can use the rule to find the elements of the range (elements of the second set).

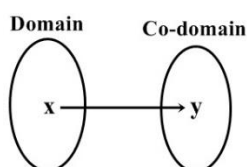

- The set of all possible images of the domain is called the range. The range is a subset of the co-domain.
- In other words, the co-domain is the set of all values that may possibly result from the relation. The range is the set of values that actually does result from the relation.

A mapping can be described with a rule or formula.

The mapping is linear, if the difference between the consecutive terms in both the domain and co-domain are constant.

- Linear rule:  $y = mx + b$ ,  $m = \frac{\text{change in co-domain}}{\text{change in domain}}$  and  $b$  can be found by picking a value from a co-domain ( $y$ ) and a value from a domain ( $x$ ) and substituting them in the linear rule.

The mapping is exponential if the ratios between the consecutive elements in the co-domain are the same.

- It is written as  $y = pr^{x-q}$  where  $p$  is the first element in the co-domain,  $q$  is the first element in the domain and  $r$  is the common ratio of the elements in the range.

## Solved Examples

1. For the relation illustrated by the diagram:

- List the elements in the domain.
- List the elements in the range.
- List the elements in the co-domain.
- Comment on the elements in the domain and the range.

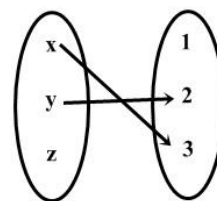

### Solutions:

- The elements in the domain are:  $\{x, y, z\}$
- The elements in the range are:  $\{2, 3\}$
- The elements in the co-domain are:  $\{1, 2, 3\}$
- It can be observed that the element  $\{1\}$  in the co-domain has no associated element with it in the domain, hence it is outside the range of the domain.

2. Find the rule of the following mapping:

$x$	0	2	4	6
	↓	↓	↓	↓
	↓	↓	↓	↓
$y$	1	3	5	7

### Solution:

Using the principle of constant difference between elements of the domain and co-domain we see that:

The difference between successive elements of the co- domains is:

$$3 - 1 = 5 - 3 = 7 - 5 = 2$$

Similarly, the difference between successive elements of the domain is:

$$2 - 0 = 4 - 2 = 6 - 4 = 2$$

Now for a linear mapping, the general rule is:

$$y = ax + b, \text{ where } a = \frac{\text{constant difference of co-domain}}{\text{constant difference of domain}}$$

$$a = \frac{2}{2} = 1, \text{ so } y = x + b$$

Now when  $x = 0, y = 1$  so  $1 = 0 + b$ , which gives  $b = 1$ .

The rule is  $y = x + 1$ .

3. Find the rules for the following mapping:

a.

$x$	0	1	2	3	4
	↓	↓	↓	↓	↓
	↓	↓	↓	↓	↓
$y$	32	16	8	4	2

b.

$x$	1	2	3	4	5
	↓	↓	↓	↓	↓
	↓	↓	↓	↓	↓
$y$	1	4	16	64	256

### Solutions:

- This mapping is not a linear mapping since there is no constant difference between successive elements of the co-domain:

$$16 - 32 \neq 8 - 16 \neq 4 - 8 \neq 2 - 4$$

Though, there is a constant difference between the successive elements of the domain.

The mapping is an exponential mapping conforming to the general rule  $y = pr^{x-q}$

Where  $p$  = First element of co-domain

$r$  = Constant ratio of successive elements of the co-domain

$q$  = First elements of domain

$$\text{So, } p = 32, r = \frac{16}{32} = \frac{8}{16} = \frac{4}{8} = \frac{2}{4} = \frac{1}{2} \text{ and } q = 0$$

$$\text{So } y = 32 \left(\frac{1}{2}\right)^{x-0} = 32 \left(\frac{1}{2}\right)^x$$

$$y = 32 \left(\frac{1}{2}\right)^x \text{ is the rule}$$

b. The mapping is an exponential mapping of the general form  $y = pr^{x-q}$ , where:

$p = 1$  (First element of co-domain)

$$r = \frac{4}{1} = \frac{16}{4} = 4 \text{ (Common ratio successive elements of co-domain)}$$

$q = 1$  (First element of domain)

$$\text{So } y = (1)(4)^{x-1}$$

$$y = 4^{x-1} \text{ is the rule}$$

## Practice

1. For the relation illustrated by the diagram below:

- List the elements in the domain.
- List the elements in the range.
- List the elements in the co-domain.
- Comment on the elements in the co-domain and range.

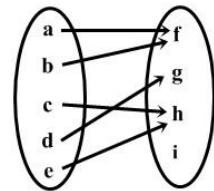

e. Does the relation qualify as a mapping or not? State the reason(s) why.

2. Considering the ordered pairs of the relation giving below:

$$\{(p, e) (p, d) (a, r) (b, f) (c, g)\}$$

- List the elements in the domain.
- List the elements in the co-domain.
- Illustrate the relation by an arrow diagram.
- Is the relation a mapping or not?

3. Find the rule for the following mappings:

a.

$x$	0	1	2	3	4
	↓	↓	↓	↓	↓
$y$	3	5	7	9	11

b.

$x$	-2	-1	0	1	2
	↓	↓	↓	↓	↓
$y$	2	4	8	16	32

4. Find the missing element represented by p or q in the mapping below:

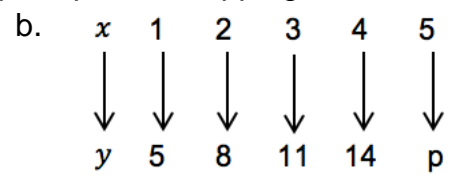
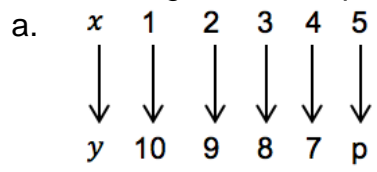

<b>Lesson Title:</b> Functions – Part 1	<b>Theme:</b> Algebraic Processes
<b>Practice Activity:</b> PHM1-L099	<b>Class:</b> SSS 1



### Learning Outcomes

By the end of the lesson, you will be able to:

1. Identify functions from certain relations.
2. Use function notation.

### Overview

A **function** is a mapping in which each element in the domain is mapped onto one and only one member on the co-domain. For example, the following are examples of functions:

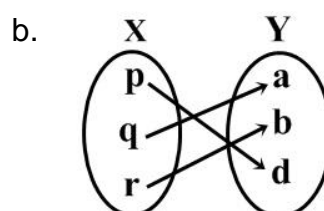
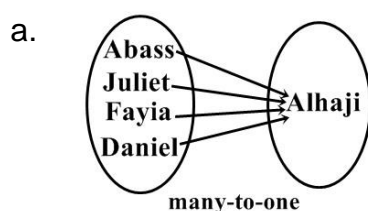

Function notation is another way of writing equations. You have probably seen equations written with  $y$ . In function notation,  $y$  is replaced with  $f(x)$ . In other words,  $y = f(x)$ . It is read as "f at x" or "f of x".

The notation  $f: x \rightarrow y$  tells us that the function's name is "f" and its ordered pairs are formed by elements  $x$  from the domain and elements  $y$  from the range. The arrow  $\rightarrow$  is read "is mapped to".

### Solved Examples

1. Given the function  $f(x) = 2x - 1$ , find the range of  $f(x)$  for  $x = 0, 1, -1, 10$ .

**Solution:**

$$\begin{aligned}
 f(x) &= 2x - 1 && \text{Function} \\
 f(0) &= 2(0) - 1 && \text{Substitute } x = 0 \\
 &= 0 - 1 && \text{Simplify} \\
 &= -1 \\
 f(x) &= 2x - 1 && \text{Function} \\
 f(1) &= 2(1) - 1 && \text{Substitute } x = 1 \\
 &= 2 - 1 && \text{Simplify} \\
 &= 1 \\
 f(x) &= 2x - 1 && \text{Function} \\
 f(-1) &= 2(-1) - 1 && \text{Substitute } x = -1 \\
 &= -2 - 1 && \text{Simplify} \\
 &= -3
 \end{aligned}$$



$$\begin{aligned}
 f(x) &= 2x - 1 && \text{Function} \\
 f(10) &= 2(10) - 1 && \text{Substitute } x = 10 \\
 &= 20 - 1 && \text{Simplify} \\
 &= 19
 \end{aligned}$$

The range is  $-1, 1, -3, 19$

2. Given the function  $f: x \rightarrow 2x^2 - 1$  defined on the domain  $\{-1, 0, 1, 2\}$  determine the range. Draw an arrow diagram to determine whether the function is a one-to-one function.

**Solution:**

$$\begin{aligned}
 f: x &\rightarrow 2x^2 - 1 \\
 f(x) &= 2x^2 - 1 && \text{Function} \\
 f(-1) &= 2(-1^2) - 1 && \text{Substitute } x = -1 \\
 &= 2 - 1 && \text{Simplify} \\
 &= 1 \\
 f(0) &= 2(0^2) - 1 && \text{Substitute } x = 0 \\
 &= 0 - 1 && \text{Simplify} \\
 &= -1 \\
 f(1) &= 2(1^2) - 1 && \text{Substitute } x = 1 \\
 &= 2 - 1 && \text{Simplify} \\
 &= 1 \\
 f(2) &= 2(2^2) - 1 && \text{Substitute } x = 2 \\
 &= 8 - 1 && \text{Simplify} \\
 &= 7
 \end{aligned}$$

The range of the functions is  $\{-1, 1, 7\}$

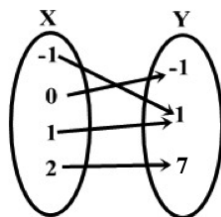

$f: x \rightarrow 2x^2 - 1$  is a many-to-one function (it is not a one-to-one function since elements  $-1$  and  $1$  in domain have the same image  $1$  in the co-domain).

3. A function is defined by  $f: x \rightarrow 5x - 3$  on the domain  $\{-2, -1, 0, 2\}$
- Find the image of the following elements. The “image” is the value in the range that corresponds to the given values of the domain.
    - $-2$
    - $0$
  - What elements of the domain correspond to the following images:
    - $-13$
    - $-4$

### Solutions:

a. i. For  $x = -2$

$$\begin{aligned} f(-2) &= 5(-2) - 3 \\ &= -10 - 3 \\ &= -13 \end{aligned}$$

a. ii. For  $x = 0$

$$\begin{aligned} f(0) &= 5(0) - 3 \\ &= 0 - 3 \\ &= -3 \end{aligned}$$

b.  $f: x \rightarrow 5x - 3$

$$f(x) = 5x - 3$$

i.  $f(x) = -13$  we have

$$\begin{aligned} -13 &= 5x - 3 \\ -13 + 3 &= 5x \\ 5x &= -10 \\ x &= -\frac{10}{5} = -2 \end{aligned}$$

ii.  $f(x) = -4$

$$\begin{aligned} -4 &= 5x - 3 \\ -4 + 3 &= 5x \\ 5x &= -1 \\ x &= -\frac{1}{5} \end{aligned}$$

### Practice

- Given the function  $f: x \rightarrow x^2 + 2$  defined on the domain  $\{-1, 0, 1, 2\}$ , determine the range. Use arrow diagrams to show whether  $f$  is one-to-one or not.
- Determine whether each of the following diagrams represents a function, and give reason to support your answer.

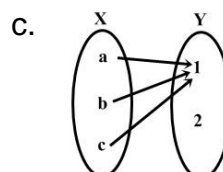
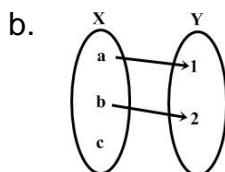
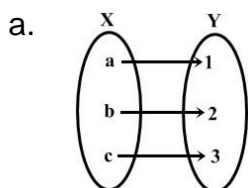

- Write the following in function notation:

a.  $w = 3t - 5$    b.  $p = 4x + 3$    c.  $g = \frac{x^2-1}{x^2+1}$    d.  $h = \frac{2x-1}{2x+1}$

- Given the function  $f: x \rightarrow \frac{2x-1}{x-2}$  on the domain  $\{-2, -1, 0, 1\}$

- Find the images of the following elements of the domain:  $\{-2, -1, 0, 1\}$
- What element of the domain corresponds to the following images?

i.  $\frac{2}{3}$    ii. 3

<b>Lesson Title:</b> Functions – Part 2	<b>Theme:</b> Algebraic Processes
<b>Practice Activity:</b> PHM1-L100	<b>Class:</b> SSS 1



### Learning Outcome

By the end of the lesson, you will be able to give reasons why a given relation is not a function.

### Overview

Recall that a function is a relation between two sets: the domain and the co-domain, such that every element of the domain has **only one** image in the co-domain.

- A function can be a one-to-one relation or a many-to-one relation.
- Any other relation (i.e. one-to-many or many-to-many) is not a function.

### Solved Examples

1. Given the ordered pairs, determine whether the sets of numbers represent a function or not.

- $\{(0, 4), (-1, 3), (1, -2), (3, 9), (3, 3)\}$
- $\{(a, 1), (b, 2), (c, 3), (b, 4), (e, 5)\}$

#### Solutions:

- The ordered pairs  $\{(0, 4), (-1, 3), (1, -2), (3, 9), (3, 3)\}$  cannot be a function since elements 3 maps to 9 and 3. This represents a one-to-many relation which does not qualify as a function.
- The ordered pairs  $\{(a, 1), (b, 2), (c, 3), (b, 4), (e, 5)\}$  represent a relation that qualifies as a function since every element in the domain maps onto only one element in the co-domain.

2. Given the relations expressed in the mapping diagrams, are the relations expressed in the mapping diagrams functions? Give your reasons.

a.

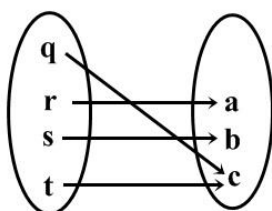

b.

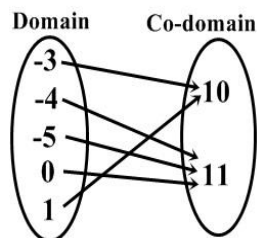

#### Solutions:

- This mapping represents a relation that qualifies as a function since every element in the domain maps to only one image in the co-domain. (we have a one-to-one relation and hence a one-to-one function)

- b. This mapping represents a relation that qualifies as a function, in that every element in the domain maps to only one element in the co-domain. (we have a many-to-one relation and hence a many-to-one function)

3. Given the relation expressed in the mapping diagrams, establish whether they qualify as functions or not:

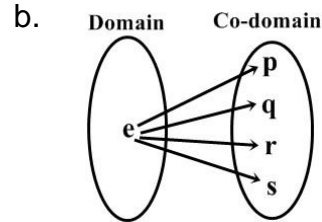
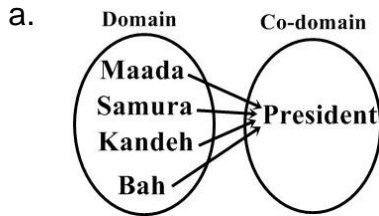

- a. This mapping represents a relation that qualifies as a function. This is because every element in the domain has one image (President) in the co-domain. It is a case of many-to-one relation and hence a many-to-one function.
- b. This mapping represents a relation that does not qualify as a function. This is because the only element in the domain has more than one image in the co-domain. This is a case of one-to-many relation which cannot be a function.

### Practice

1. Given the ordered pairs, determine whether the sets of numbers represent a function or not:

a.  $\{(1, 5), (1, 6), (1, 7), (1, 8)\}$

b.  $\{(5, 1), (6, 1), (7, 1), (8, 1)\}$

2. Identify whether the following mappings are functions:

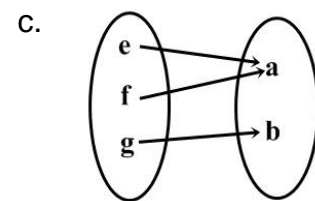
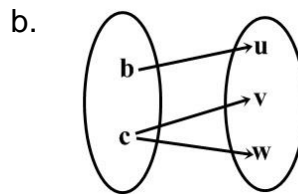
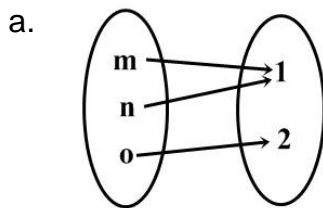

3. Given the relation expressed in the mapping diagram, establish whether they qualify as function or not:

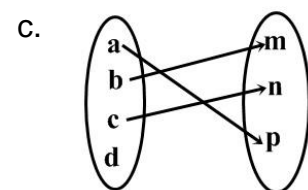
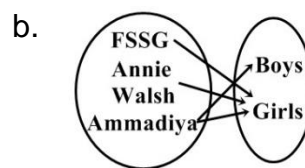
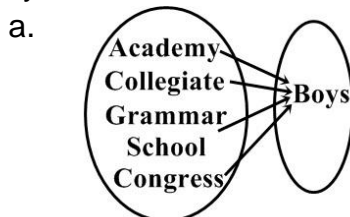

<b>Lesson Title:</b> Graphs of linear functions – Part 1	<b>Theme:</b> Algebraic Processes
<b>Practice Activity:</b> PHM1-L101	<b>Class:</b> SSS 1



### Learning Outcomes

By the end of the lesson, you will be able to:

1. Identify linear functions.
2. Make tables of values for given linear functions.

### Overview

A linear function of  $x$  is one which contains  $x$  with a power of only 1. Linear functions usually have 2 variables,  $x$  and  $y$ . Remember that in function notation,  $y$  is replaced by  $f(x)$ .

In this lesson, we will fill tables of values with solutions to linear equations. A solution to a linear equation is an  $x$ -value and a corresponding  $y$ -value that satisfy the equation. Each column in a table of values gives an  $x$ - and  $y$ -value that make an ordered pair  $(x, y)$ . These tables of values will be used in the next lesson to graph lines from ordered pairs.

### Solved Examples

1. Create a table of values for the linear equation  $y = 7 - 2x$  for values of  $x$  from  $-3$  to  $+3$

#### Solution:

Substitute the values of  $x$ , in the linear equation to get the corresponding values of  $y$ :

$$\begin{array}{ll}
 \text{When } x = -3, & f(-3) = 7 - 2(-3) = 13 \\
 x = -2, & f(-2) = 7 - 2(-2) = 11 \\
 x = -1, & f(-1) = 7 - 2(-1) = 9 \\
 x = 0, & f(0) = 7 - 2(0) = 7 \\
 x = 1, & f(1) = 7 - 2(1) = 5 \\
 x = 2, & f(2) = 7 - 2(2) = 3 \\
 x = 3, & f(3) = 7 - 2(3) = 1
 \end{array}$$

The table of values for the linear equation  $y = 7 - 2x$ :

$x$	-3	-2	-1	0	1	2	3
$y$	13	11	9	7	5	3	1

2. Copy and complete a table of values for the linear equation  $y = \frac{1}{2}x + 2$ .

$x$	-3	-2	-1	0	1	2	3
$y$	0.5			2		3	

**Solution:**

We only need to find the  $y$ -values that are missing in the table:

$$\text{When } x = -2, \quad y = \frac{1}{2}(-2) + 2 = -1 + 2 = 1$$

$$\text{When } x = -1, \quad y = \frac{1}{2}(-1) + 2 = -0.5 + 2 = 1.5$$

$$\text{When } x = 1, \quad y = \frac{1}{2}(1) + 2 = 0.5 + 2 = 2.5$$

$$\text{When } x = 3, \quad y = \frac{1}{2}(3) + 2 = 1.5 + 2 = 3.5$$

$x$	-3	-2	-1	0	1	2	3
$y$	0.5	1	1.5	2	2.5	3	3.5

3. Create a table of values for the linear equation  $y - 1 = 2x$  for values of  $x$  from  $-3$  to  $+3$ .

**Solution:**

First, make  $y$  the subject of the equation:

$$y - 1 = 2x$$

$$y = 2x + 1$$

Substitute values of  $x$  and evaluate:

$$\text{When } x = -3, \quad y = 2(-3) + 1 = -5$$

$$x = -2, \quad y = 2(-2) + 1 = -3$$

$$x = -1, \quad y = 2(-1) + 1 = -1$$

$$x = 0, \quad y = 2(0) + 1 = 1$$

$$x = 1, \quad y = 2(1) + 1 = 3$$

$$x = 2, \quad y = 2(2) + 1 = 5$$

$$x = 3, \quad y = 2(3) + 1 = 7$$

The table of values for the equation  $y = 2x + 1$  is:

$x$	-3	-2	-1	0	1	2	3
$y$	-5	-3	-1	1	3	5	7

4. Copy and complete the table of the relation  $y + 2x = 0$ :

$x$	-4	-3	-2	-1	0	1	2	3
$y$		6				-2		

**Solution:**

First, make  $y$  the subject of the equation:

$$y + 2x = 0$$

$$y = 0 - 2x$$

$$y = -2x$$

Substitute values of  $x$  and evaluate:

$$\text{When } x = -4 \quad y = -2(-4) = 8$$

$$x = -2 \quad y = -2(-2) = 4$$

$$x = -1 \quad y = -2(-1) = 2$$

$$\begin{array}{lcl}
 x = 0 & y = -2(0) & = 0 \\
 x = 2 & y = -2(2) & = -4 \\
 x = 3 & y = -2(3) & = -6
 \end{array}$$

$x$	-4	-3	-2	-1	0	1	2	3
$y$	8	6	4	2	0	-2	-4	-6

### Practice

1. Create a table of values for the equation  $y = 2x + 3$  for values of  $x$  from  $-3$  to  $+3$ .
2. Create a table of values for the equation  $y + 6 = 3x$  for values of  $x$  from  $-4$  to  $+2$ .
3. Copy and complete the table of values for the relation  $2y = x + 5$ :

$x$	-3	-2	-1	0	1	2	3
$y$		1.5					

4. Create a table of values for the equation  $y = 3 - 2x$  for values of  $x$  from  $-2$  to  $+4$ .
5. Copy and complete the table of values for the relation  $y - 5 = 2x$ :

$x$	-3	-2	-1	0	1	2	3
$y$	-1			5			

<b>Lesson Title:</b> Graphs of linear functions – Part 2	<b>Theme:</b> Algebraic Processes
<b>Practice Activity:</b> PHM1-L102	<b>Class:</b> SSS 1

	<p><b>Learning Outcome</b> By the end of the lesson, you will be able to use tables of values to draw straight line graphs within Cartesian axes.</p>
---	---

## Overview

The Cartesian plane has 2 intersecting axes, the  $x$ -axis and  $y$ -axis. They both have positive and negative directions.

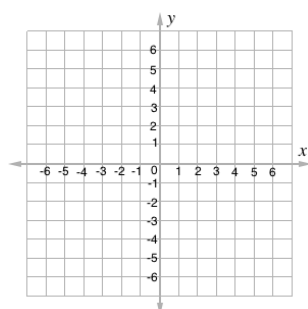

The  $x$ -axis is horizontal. The values increase as you go to the right. Negative values are on the left. The  $y$ -axis is vertical. The values increase as you go up. Negative values are below the  $x$ -axis. It is important that the tick marks (numbers) on the axes are the same distance apart from one another.

This lesson is on graphing linear equations. Solutions to linear equations can be written as ordered pairs:  $(x, y)$ . To find a solution to a linear equation, substitute any value of  $x$  and solve for  $y$ . Solutions can be recorded in a table of values and graphed on the Cartesian plane.

## Solved Examples

- Write another problem on the board. Draw the graph of the relation  $f(x) = 6 - \frac{1}{2}x$  using the table of values below. Use a scale of 2 cm to 1 unit on both axes.

$x$	-3	-2	-1	0	1	2	3	4
$f(x)$	7.5	7	6.5	6	5.5	5	4.5	4

### Solution:

In this case, the table of values is given. Each point can be plotted on the Cartesian plane and connected with a straight line.

Note that the ordered pairs in the table of values are  $(-3, 7.5)$ ,  $(-2, 7)$ , and so on.

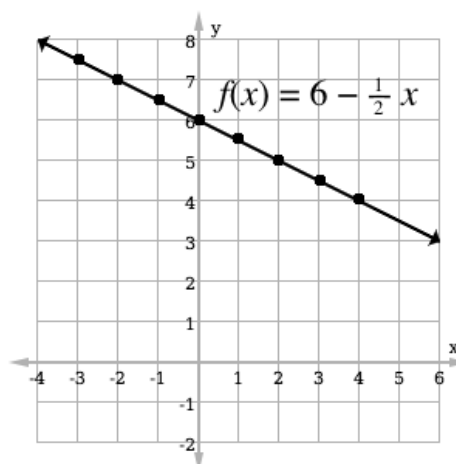



Note that the graph is not drawn to the correct scale (2 cm). You will often be asked to draw your Cartesian plane with a certain scale. Check your plane with a ruler to make sure it is to scale.

2. Draw a table of values of  $x$  from  $-2$  to  $+2$  of the relation  $f(x) = 4 - x$ . Use the table of values to graph the function.

**Solution:**

Draw the table of values with values of  $x$  from  $-2$  to  $+2$ . Then, substitute each value of  $x$  into the given function.

$$f(-2) = 4 - (-2) = 4 + 2 = 6$$

$$f(1) = 4 - (1) = 4 - 1 = 3$$

$$f(-1) = 4 - (-1) = 4 + 1 = 5$$

$$f(2) = 4 - (2) = 4 - 2 = 2$$

$$f(0) = 4 - (0) = 4 - 0 = 4$$

Write the results in the table of values:

$x$	$-2$	$-1$	$0$	$1$	$2$
$f(x)$	$6$	$5$	$4$	$3$	$2$

Plot each point on the Cartesian plane, and connect them in a line:

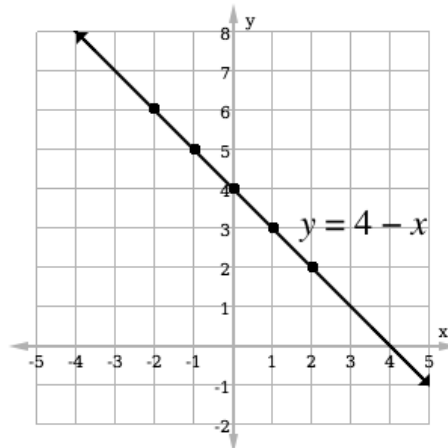

3. Draw the graph of the relation  $y = 3x + 2$  for values of  $x$  from  $-2$  to  $+3$ . Use a scale of 2 cm to 1 unit on the  $x$  axis and 2 cm to 2 units on the  $y$  axis

**Solution:**

First, complete the table of values as shown below:

$x$	$-2$	$-1$	$0$	$1$	$2$	$3$
$y$	$-4$	$-1$	$2$	$5$	$8$	$11$

Draw the  $x$ -axis and the  $y$ -axis. Mark the  $x$ -axis every 2 cm to 1 unit, and mark the  $y$ -axis every 2 cm to 2 units. Make sure the axes extend beyond the values in the table.

Plot the points on the plane using the values from the table, and connect them with a straight line.

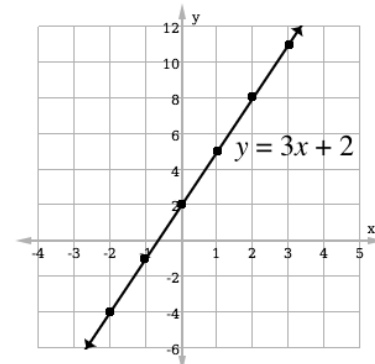

4. Draw the graph of the relation  $y = 7 - 2x$  for values of  $x$  from  $-3$  to  $+3$ . Use the table of values as shown below.

$x$	$-3$	$-2$	$-1$	$0$	$1$	$2$	$3$
$y$	$13$	$11$	$9$	$7$	$5$	$3$	$1$

**Solution:**

The scale is not given, therefore we identify the smallest and the largest values of  $x$ , that is  $-3$  and  $+3$  respectively. The smallest value of  $y$  is  $1$  and the largest value is  $13$ . You can come up with your own scale that can absorb all the values in the table.

This example uses  $2$  cm to  $1$  unit on the  $x$ -axis and  $2$  cm to  $2$  units on the  $y$ -axis. This scale will absorb the larger values of  $y$ .

Mark the  $x$ -axis  $2$ cm to  $1$  unit from  $-4$  to  $4$ .

Mark the  $y$ -axis  $2$ cm to  $2$  units from  $-2$  to  $14$ .

Plot the points on the plane using the values from the table.

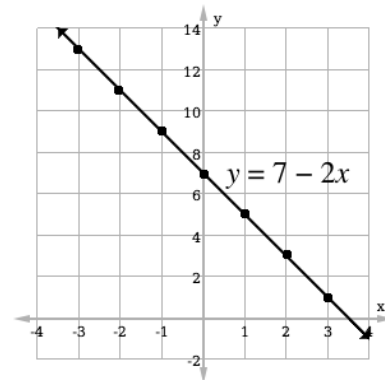

**Practice**

1. Draw the graph of the relation  $y = 2x + 3$  for values of  $x$  from  $-3$  to  $3$ . Use a scale of  $2$  cm to  $1$  unit on the  $x$  axis and  $2$  cm to  $2$  units on the  $y$  axis. Use the completed table below

$x$	$-3$	$-2$	$-1$	$0$	$1$	$2$	$3$
$y$	$-3$	$-1$	$1$	$3$	$5$	$7$	$9$

2. Draw the graph of the relation  $x + 2y = 7$  for values of  $x$  from  $-2$  to  $2$ . Use the completed table below.

$x$	$-2$	$-1$	$0$	$1$	$2$
$y$	$4.5$	$4$	$3.5$	$3$	$2.5$

3. Create a table of values and draw the graph of the relation  $y = 3 - 2x$  for values of  $x$  from  $-2$  to  $+3$ .

4. a. Copy and complete the table of values for the relation,  $3x - y = 1$  for values of  $x$  from  $-3$  to  $3$ .

$x$	$-3$	$-2$	$-1$	$0$	$1$	$2$	$3$
$y$		$-7$		$-1$			

- b. Draw the graph of the relation  $3x - y = 1$

<b>Lesson Title:</b> Quadratic Functions	<b>Theme:</b> Algebraic Processes
<b>Practice Activity:</b> PHM1-L103	<b>Class:</b> SSS 1



### Learning Outcome

By the end of the lesson, you will be able to construct tables of values for given quadratic functions.

## Overview

A quadratic function of  $x$  is one which contains terms in  $x$ , with a power of 2 on one of the  $x$  variables. If the function has a power greater than 2 on  $x$ , it is not a quadratic function.

A quadratic function has 2 variables,  $x$  and  $y$ . The value of  $y$  will change depending on the value of  $x$ .  $y$  is called the dependent variable, and  $x$  is called the independent variable.

As with linear functions, we can create a table of values and graph a quadratic function. Two methods of creating a table of values are shown here. Solved Example 1 shows the substitution method, and solved example 2 shows the tabular method.

## Solved Examples

1. Create a table of values for the relation  $y = x^2$  for  $-3 \leq x \leq 3$ .

### Solution:

Substitute the values of  $x$  into the given relation to find the corresponding  $y$  value.

$$\begin{array}{ll}
 \text{When } x = -3, & y = (-3)^2 = 9 \\
 x = -2, & y = (-2)^2 = 4 \\
 x = -1, & y = (-1)^2 = 1 \\
 \text{When } x = 0, & y = (0)^2 = 0 \\
 x = 1, & y = (1)^2 = 1 \\
 x = 2, & y = (2)^2 = 4 \\
 x = 3, & y = (3)^2 = 9
 \end{array}$$

Write the values of  $x$  and  $y$  in the tabular form:

$x$	-3	-2	-1	0	1	2	3
$y$	9	4	1	0	1	4	9

2. Create a table of values for the relation  $y = x^2 + 2x + 1$  for  $-3 \leq x \leq 3$ .

### Solution:

There is another method of writing the table of values. This method is completed in a table rather than working separately. The first row is for the given values of  $x$ . The next rows are for the terms of the quadratic function. The last row is for the  $y$ -values. These are found by adding the rows for the terms.

Table of values for  $y = x^2 + 2x + 1$ :

$x$	-3	-2	-1	0	1	2	3
$x^2$	9	4	1	0	1	4	9
$2x$	-6	-4	-2	0	2	4	6
1	1	1	1	1	1	1	1
$y$	4	1	0	1	4	9	16

In this case, the first row gives the values of  $x$  second row gives values of  $x^2$ , third row gives the product 2 and  $x$  and forth row gives the constant 1. The  $y$  value is the sum of  $x^2 + 2x + 1$ .

3. Create a table of values for the relation  $y = 2x^2 + 3x - 5$ , for  $-2 \leq x \leq 3$ .

**Solution:**

Substitute the values of  $x$  into the given relation to find the corresponding  $y$  value.

$$\text{When } x = -2 \quad y = 2(-2)^2 + 3(-2) - 5$$

$$= 8 - 6 - 5$$

$$= -3$$

$$x = -1 \quad y = 2(-1)^2 + 3(-1) - 5$$

$$= 2 - 3 - 5$$

$$= -6$$

$$x = 0 \quad y = 2(0)^2 + 3(0) - 5$$

$$= -5$$

$$x = 1 \quad y = 2(1)^2 + 3(1) - 5$$

$$= 2 + 3 - 5$$

$$= 0$$

$$x = 2 \quad y = 2(2)^2 + 3(2) - 5$$

$$= 8 + 6 - 5$$

$$= 9$$

$$x = 3 \quad y = 2(3)^2 + 3(3) - 5$$

$$= 18 + 9 - 5$$

$$= 22$$

Table of values for  $y = 2x^2 + 3x - 5$ :

$x$	-2	-1	0	1	2	3
$y$	-3	-6	-5	0	9	22

4. Draw a table with values of  $x$  from  $-2$  to  $+4$  for the quadratic function  $y = 3 + 5x - 2x^2$ .

**Solution:**

$$\text{When } x = -2 \quad y = 3 + 5(-2) - 2(-2)^2$$

$$= 3 - 10 - 8$$

$$= -15$$

$$x = -1 \quad y = 3 + 5(-1) - 2(-1)^2$$

$$= 3 - 5 - 2$$

$$= -4$$

$$\begin{aligned}
 x = 0 & \quad y = 3 + 5(0) - 2(0)^2 \\
 & \quad = 3 \\
 x = 1 & \quad y = 3 + 5(1) - 2(1)^2 \\
 & \quad = 3 + 5 - 2 \\
 & \quad = 6 \\
 x = 2 & \quad y = 3 + 5(2) - 2(2)^2 \\
 & \quad = 3 + 10 - 8 \\
 & \quad = 5 \\
 x = 3 & \quad y = 3 + 5(3) - 2(3)^2 \\
 & \quad = 3 + 15 - 18 \\
 & \quad = 0
 \end{aligned}$$

Table of values for  $y = 3 + 5x - 2x^2$ :

$x$	-2	-1	0	1	2	3
$y$	-15	-4	3	6	5	0

5. Draw a table with values of  $x$  from  $-3$  to  $+3$  for the quadratic function  $y = 2x^2 + x - 1$ .

**Solution:**

Using the tabular method, the table of values for  $y = 2x^2 + x - 1$  is:

$x$	-3	-2	-1	0	1	2	3
$2x^2$	18	8	2	0	2	8	18
$x$	-3	-2	-1	0	1	2	3
$-1$	-1	-1	-1	-1	-1	-1	-1
$y$	14	5	0	-1	2	9	20

### Practice

1. Draw a table with values of  $x$  from  $-3$  to  $+3$  for the equation  $y = 3x^2 - 2x + 1$
2. Draw a table with values of  $x$  from  $-2$  to  $+3$  for the equation  $y = 5 - x - 2x^2$ .
3. Create a table of values for the relation  $y = 2x^2 + x - 3$  for  $-2 \leq x \leq +3$ . Use either substitution or tabular form.
4. Draw a table with values of  $x$  from  $-1$  to  $+4$  for the equation  $y = 2 - x - x^2$ , using substitution.
5. Create a table of values for the relation  $y = x^2 + 5x - 1$  for values of  $x$  from  $-3$  to  $+3$ , using tabular method.

<b>Lesson Title:</b> Quadratic functions on the Cartesian Plane- Part 1	<b>Theme:</b> Algebraic Processes
<b>Practice Activity:</b> PHM1-L104	<b>Class:</b> SSS 1

	<p><b>Learning Outcome</b> By the end of the lesson, you will be able to use table of values to draw the graphs of quadratic functions on the Cartesian plane.</p>
---	--

### Overview

To draw a quadratic graph, the procedure is the same as that of a linear function. Identify ordered pairs from a table of values, and plot them on the Cartesian plane. Connect them with a curve.

Remember  $x$  is the independent variable. We choose its value, and use it to find  $y$ , the dependent variable. The scale we use to draw the plane and plot the points depends on the scale given on the question.

The graph of a quadratic function is a curve called a parabola. Parabolas are shaped like the letter u or the letter n. In other words, they can open up or down.

### Solved Examples

1. Draw the graph of  $y = x^2$  from the table below.

$x$	-3	-2	-1	0	1	2	3
$y$	9	4	1	0	1	4	9

#### Solution:

The scale we use to plot the points depends on the scale given on the question. In this case, the  $x$ -values are  $-3 \leq x \leq 3$ , and the  $y$ -values are  $0 \leq y \leq 9$ . We can use a scale of 2 cm to 1 unit on both axes.

Plot the points from the table and connect them with a curve:

Note that the graph is not drawn to scale. Make sure that your own graph has a scale of 2 cm.

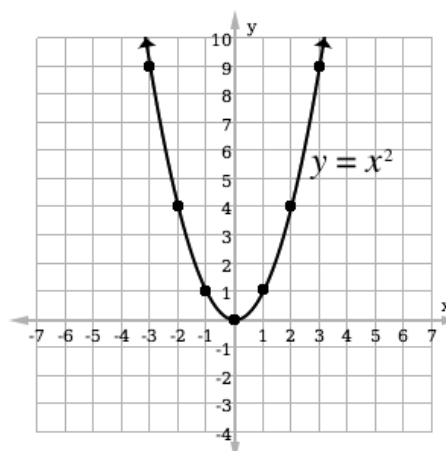

2. Use the table of values below to draw the graph of the function  $f(x) = 2 + 3x - x^2$  in the interval  $-3 \leq x \leq 6$ . Use a scale of 2 cm to 1 unit on the  $x$ -axis and 2 cm to 5 units on the  $y$ -axis.

$x$	-3	-2	-1	0	1	2	3	4	5	6
$f(x)$	-16	-8	-2	2	4	4	2	-2	-8	-16

**Solution:**

In this case, the  $x$ -values are  $-3 \leq x \leq 6$ , and the  $y$ -values are  $-16 \leq y \leq 4$ . Thus, it makes sense to use the scale of 2 cm to 1 unit on the  $x$ -axis and 2 cm to 5 units on the  $y$ -axis.

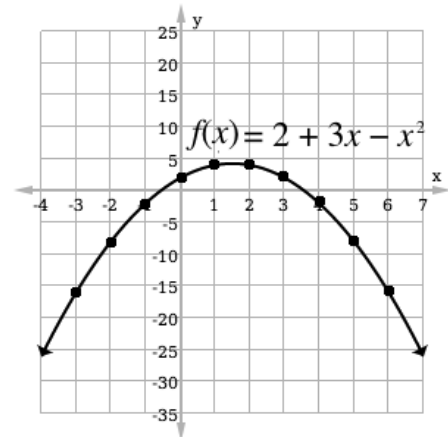

Plot the points from the table and connect them with a curve:

3. Draw the graph of  $y = 3x^2 - 4x - 1$ , using the table below. Use a scale of 2 cm to 1 unit on the  $x$  axis and 2cm to 5 units on the  $y$  axis.

$x$	-3	-2	-1	0	1	2	3
$y$	38	19	6	-1	-2	3	14

**Solution:**

Plot the points in the table of values use free hand to join all the points you have plotted.

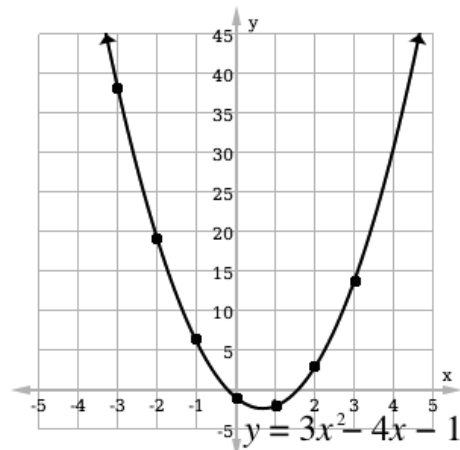

**Practice**

1. Copy and complete the table of values for  $y = 3x^2 - x + 1$ , below. Use the scale of 2 cm to 1 unit on the  $x$ -axis and 2 cm to 2 units on the  $y$ -axis, draw the graph of the relation.

$x$	-2	-1	0	1	2	3
$y$						

2. Use a scale of 2 cm to 1 units on the  $x$ -axis and 2cm to 2 units on the  $y$  axis to plot the graph of  $y = 2x^2 + x - 3$  from the table below.

$x$	-2	-1	0	1	2	3
$y$	3	-2	-3	0	7	18

3. Complete the table of values below and draw the graph of  $y = 2x^2 - x + 3$  from the table.

$x$	-2	-1	0	1	2
$y$					

4. Use a suitable scale to graph the relation  $y = 2 - x - x^2$  from the table below.

$x$	-3	-2	-1	0	1	2	3
$y$	-4	0	2	2	0	-4	-10



<b>Lesson Title:</b> Quadratic functions on the Cartesian plane - Part 2	<b>Theme:</b> Algebraic Processes
<b>Practice Activity:</b> PHM1-L105	<b>Class:</b> SSS 1

	<p><b>Learning Outcome</b> By the end of the lesson, you will be able to draw a smooth parabolic curve through plotted points.</p>
---	--

### Overview

This is the second lesson on graphing quadratic functions. Recall that the graph of a quadratic function is a parabola.

### Solved Examples

- The following are solutions to the quadratic equation  $y = x^2 - 4x - 6$ . Use a scale of 2 cm to 1 unit on both axes to graph the curve through these ordered pairs:  $(-2, 6), (0, -6), (1, -9), (3, -9), (4, -6), (6, 6)$ .

**Solution:**

Draw the Cartesian plane. Plot the points and use your free hand to draw a smooth curve through the points. The complete graph is shown below

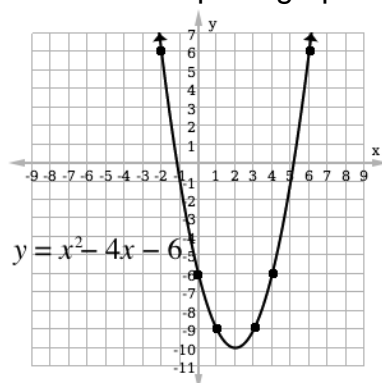

- The table below is for the function  $y = x^2 + 4x - 2$ . Use the table to draw the graph of  $y = x^2 + 4x - 2$ , using a scale of 2 cm to 1 unit on the  $x$ -axis and 2 cm to 2 units on the  $y$ -axis.

$x$	-6	-5	-4	-2	0	1	2
$y$	10	5	-2	-6	-2	3	10

**Solution:**

Draw the plane using a scale of 2cm to 1 unit on the  $x$ -axis and 2 cm to 2 units on  $y$ -axis.

Plot the points, and draw a smooth curve through them.

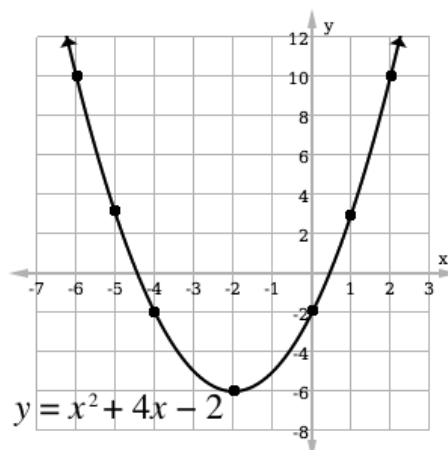

3. Use a suitable scale to graph the function  $f(x) = x^2 - 5x + 2$  on the interval  $0 \leq x \leq 6$ .

**Solution:**

In some cases, we are not given a table of values in the problem. We can create a table by writing the x-values in the table, and substituting these into the quadratic function to find the y-values.

Find the missing values for the table:

$$f(0) = (0)^2 - 5(0) + 2 = 0 + 0 + 2 = 2$$

$$f(1) = (1)^2 - 5(1) + 2 = 1 - 5 + 2 = -2$$

$$f(2) = (2)^2 - 5(2) + 2 = 4 - 10 + 2 = -4$$

$$f(3) = (3)^2 - 5(3) + 2 = 9 - 15 + 2 = -4$$

$$f(4) = (4)^2 - 5(4) + 2 = 16 - 20 + 2 = -2$$

$$f(5) = (5)^2 - 5(5) + 2 = 25 - 25 + 2 = 2$$

$$f(6) = (6)^2 - 5(6) + 2 = 36 - 30 + 2 = 8$$

Fill in the table:

$x$	0	1	2	3	4	5	6
$y$	2	-2	-4	-4	-2	2	8

Use a scale of 2cm to 1 unit on the  $x$  axis and 2 cm to 1 unit on the  $y$  axis. Plot the points in the table of values and draw a smooth curve through the points.

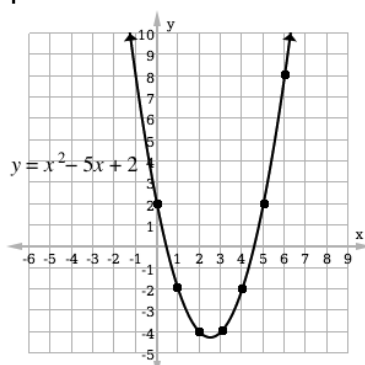

**Practice**

1. Draw a smooth parabolic curve through the following solutions of the function  $y = x^2 - 2x - 5$ :  $(-3, 10)(-2, 3)(-1, -2)(0, -5)(1, -6)(2, -5)(3, -2)$ . Use a scale of 2 cm to 1 unit on the  $x$  axis and 2cm to 2 units on the  $y$  axis.
2. Use the table below to draw the graph of the relation  $y = 1 + 3x - 2x^2$ . Use a scale of 2cm to 1 unit on the  $x$  axis and 2cm to 2 units on the  $y$  axis.

$x$	-2	-1	0	1	2	3
$y$	-13	-4	1	2	-1	-8

3. Copy and complete the table of values for the equation  $y = x^2 + 3x + 2$ . Using a scale of 2 cm to 1 unit on the  $x$  axis and 2 cm to 2 units on the  $y$  axis, plot the

points in the table of values and draw a smooth parabolic curve through the points.

$x$	-3	-2	-1	0	1	2
$y$		0				12

<b>Lesson Title:</b> Values from the graphs of quadratic functions	<b>Theme:</b> Algebraic Processes
<b>Practice Activity:</b> PHM1-L106	<b>Class:</b> SSS 1

	<p><b>Learning Outcome</b> By the end of the lesson, you will be able to read off values from the graphs of quadratic functions (including minimum and maximum values and axis of symmetry).</p>
---	--

## Overview

Consider the following figures:

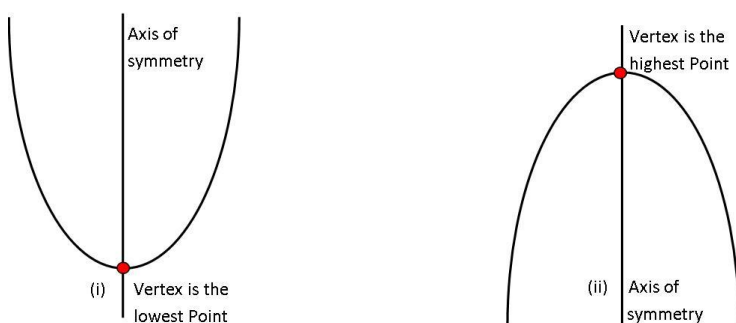

Figures (i) and (ii) are the graphs of quadratic functions, which we call parabolas. The graph on the left opens up and has a lowest point while the graph on the right opens down and has a highest point. The lowest or highest point of a parabola is called the **vertex**. The other name of the lowest point is **minimum** and the other name of the highest point is **maximum**.

The vertical line passing through the vertex in each parabola is called the **axis of symmetry** or **line of symmetry**.

## Solved Examples

1. Use the graph to find:
  - a. The co-ordinates of the maximum of  $y = 1 + 6x - x^2$
  - b. The equation of the line of symmetry of  $y = 1 + 6x - x^2$ .

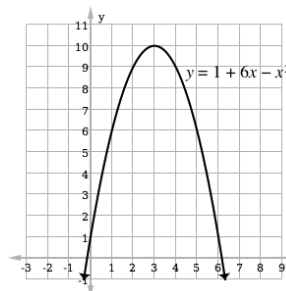

## Solutions:

- a. The maximum is the highest point on the parabola. This is (3, 10).
- b. The line of symmetry is the line that divides the graphs into two equal parts. Draw and label the line of symmetry on the graph. It is  $x = 3$ .

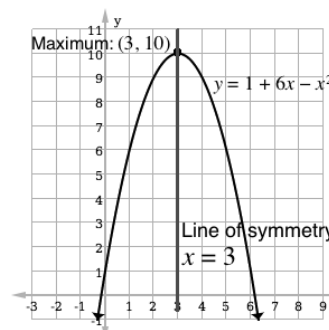

2. Use the graph below to find the following:

- a. The co-ordinates of the minimum point.
- b. The equation of the line of symmetry of  $y = x^2 - 4x - 21$ .

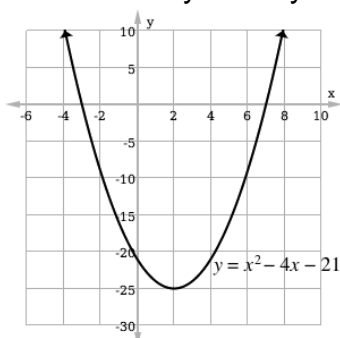

**Solutions:**

- a. Identify the minimum point on the graph, which is  $(2, -25)$ .
- b. Draw the line of symmetry on the graph and identify its equation,  $x = 2$ .

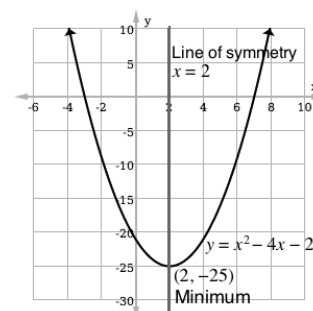

**Practice**

1.
  - a. Complete a table of values for the relation  $y = x^2 + 5x + 4$  for  $-5 \leq x \leq 0$ .
  - b. Using a scale of 2 cm to 1 unit on the x-axis and 2 cm to 1 units on the y-axis, draw the graph of  $y = x^2 + 5x + 4$ .
  - c. Use your graph to find:
    - i. The equation of the line of symmetry.
    - ii. The co-ordinates of the minimum point.
2.
  - a. Complete a table of values for the relation  $y = -x^2 - 3x + 2$  for  $-4 \leq x \leq 1$ .
  - b. Draw the graph of  $y = -x^2 - 3x + 2$ .
  - c. Use your graph to find:
    - i. The equation of the line of symmetry.
    - ii. The co-ordinates of the maximum point.
3.
  - a. Copy and complete the table of values for the relation  $y = 5 - 7x - 6x^2$  for  $-3 \leq x \leq 2$ .

$x$	-3	-2	-1	0	1	2
$y$	-28		6	5		

- b. Using a scale of 2 cm to 1 unit on the x-axis and 2 cm to 5 units on the y-axis, draw the graph of  $y = 5 - 7x - 6x^2$
- c. Use your graph to find the maximum value of  $y$ .

<b>Lesson Title:</b> Factorising Quadratic expressions	<b>Theme:</b> Algebraic Processes
<b>Practice Activity:</b> PHM1-L107	<b>Class:</b> SSS 1

	<b>Learning Outcome</b> By the end of the lesson, you will be able to factorise quadratic expressions.
---	---

## Overview

A quadratic expression has the general form  $ax^2 + bx + c$  where  $a, b$  and  $c$  are numbers. It is important to note that 2 is the highest power of  $x$  in a quadratic expression. The number  $a$  is the coefficient of  $x^2$ ,  $b$  is the coefficient of  $x$ , and  $c$  is called the constant term. These numbers can be positive or negative. The numbers  $b$  and  $c$  can also be zero.

Quadratic expressions can be factored into separate expressions, which are often 2 binomials. For example, the factorisation of  $x^2 + 7x + 10$  is  $(x + 2)(x + 5)$ .

The general rule for factorising a quadratic expression is  $ax^2 + bx + c = (x + p)(x + q)$  where  $p + q = b$  and  $p \times q = c$  when  $a = 1$ .

To factorise a quadratic expression, we can split the middle term so that it is 2 terms. This gives an expression with 4 terms, which can be factored using the same process we have used before. The middle term should be split to  $px$  and  $qx$ , where  $p$  and  $q$  sum to give  $b$  of the middle term and multiply to give  $c$  of the last term (as in the general rule above).

## Solved Examples

1. Factorise  $y^2 - 7y + 12$

### Solution:

To find  $p$  and  $q$ , note the factors of 12. They may both be positive, or both be negative:  $1 \times 12$ ,  $3 \times 4$ ,  $2 \times 6$ ,  $-1 \times -12$ ,  $-3 \times -4$ ,  $-2 \times -6$

Note that the 2 factors  $p$  and  $q$  must sum to  $-7$ . The numbers are  $-3$  and  $-4$ .

$$\begin{aligned}
 y^2 - 7y + 12 &= y^2 - \mathbf{3y} - \mathbf{4y} + 12 && \text{Split the middle term} \\
 &= y(y - 3) - 4y + 12 && \text{Factorise the first two terms} \\
 &= y(y - 3) - 4(y - 3) && \text{Factorise the last two terms} \\
 &= (y - 3)(y - 4) && \text{Factorise the common factor of } x - 3
 \end{aligned}$$

Therefore  $y^2 - 7y + 12 = (y - 3)(y - 4)$ .

2. Factorise  $x^2 + 6x + 8$

### Solution:

Factors of 8 = 1, 2, 4, 8

Product of factors  $c = 2 \times 4 = 8$

Sum of factors  $b = 2 + 4 = 6$

$$x^2 + 6x + 8 = x^2 + 2x + 4x + 8 \quad \text{Split the middle term.}$$

$$\begin{aligned}
 &= x(x + 2) + 4(x + 2) && \text{Factorise the first 2 and last 2 terms} \\
 &= (x + 2)(x + 4) && \text{Factorise the common factor of } x + 2
 \end{aligned}$$

3. Factorise  $m^2 + 8m - 33$

**Solution:**

When you encounter large numbers or a mix of positive and negative numbers, the values of  $p$  and  $q$  will not be obvious. Start by writing the factors of  $c$ :  $-33$ :  
 $-1 \times 33, 1 \times -33, -3 \times 11, 3 \times -11$

Note that  $c = -3 \times 11 = -33$  and  $b = -3 + 11 = +8$ .

Use  $p = -3$  and  $q = 11$  to factorise:

$$\begin{aligned}
 m^2 + 8m - 33 &= m^2 - 3m + 11m - 33 \\
 &= m(m - 3) + 11(m - 3) \\
 &= (m + 11)(m - 3)
 \end{aligned}$$

4. Factorise  $x^2 - 6x - 27$

**Solution:**

Factors of 27	$= 1, 2, 3, 9, 27$
Product of factors	$c = 3 \times (-9) = -27$
Sum of factors	$b = 3 - 9 = -6$
$x^2 - 6x - 27$	$= x^2 + 3x - 9x - 27$ $= x(x + 3) - 9(x + 3)$ $= (x + 3)(x - 9)$

5. One of the factors of the quadratic expression  $y^2 - 14y + 45$  is  $(y - 5)$ . Find the other factor.

**Solution:**

Product of factors:	$c = (-9) \times (-5) = +45$
Sum of factors	$b = -9 - 5 = -14$
$y^2 - 14y + 45$	$= y^2 - 9y - 5y + 45$ $= y(y - 9) - 5(y - 9)$ $= (y - 5)(y - 9)$

Hence the other factor is  $(y - 9)$ .

**Practice**

1. Factorise the following:

- a.  $x^2 + 9x + 20$
- b.  $p^2 - 11p + 24$
- c.  $y^2 - 10y + 25$
- d.  $n^2 + n - 6$

2. One of the factors of  $x^2 - 10x + 21$  is  $(x - 3)$ . Find the other factor.

3. One of the factors of  $u^2 - 5u - 6$  is  $(u - 6)$  find the other factor.

<b>Lesson Title:</b> Solving quadratic equation	<b>Theme:</b> Algebraic Processes
<b>Practice Activity:</b> PHM1-L108	<b>Class:</b> SSS 1



### Learning Outcome

By the end of the lesson, you will be able to solve quadratic equations using the principle that if  $a \times b = 0$ , then either  $a = 0$  or  $b = 0$  both  $a$  and  $b$  are 0.

## Overview

When a quadratic expression is set equal to 0, it forms a quadratic equation. A quadratic equation can be solved by finding values of  $x$  which satisfy it.

A quadratic equation can have 0, 1, or 2 solutions.

One way of solving quadratic equations is to apply the following argument to a quadratic expression that has been factorised. If the product of two numbers is 0, then one of the numbers (or possibly both of them) must be 0.

For example, the expression  $(x - 5)(x - 7) = 0$  means that 2 factors  $(x - 5)$  and  $(x - 7)$  give a product of 0 when multiplied. Using what we know of multiplication, either  $x - 5 = 0$  or  $x - 7 = 0$ . This allows us to solve for  $x$ .

## Solved Examples

1. Solve the equation  $(x + 1)(x - 2) = 0$ .

### Solution:

$(x + 1)(x - 2) = 0$  implies that either:

- $(x + 1) = 0$  because  $(0)(x - 2) = 0$ , or
- $(x - 2) = 0$  because  $(x + 1)(0) = 0$ .

This gives 2 solutions:

$$\begin{array}{lcl} x + 1 = 0 & \text{or} & x - 2 = 0 \\ x = -1 & & x = 2 \end{array}$$

The answer is  $x = -1$  or  $x = 2$ , which can also be written  $x = -1, 2$ .

2. Solve the equation  $(x + 3)(x - 1) = 0$ .

### Solution:

$(x + 3)(x - 1) = 0$ , implies that either:

- $(x + 3) = 0$ , because  $(0)(x - 1) = 0$ , or
- $(x - 1) = 0$ , because  $(x + 3)(0) = 0$

This gives 2 solutions:

$$\begin{array}{lcl} x + 3 = 0 & \text{or} & x - 1 = 0 \\ x = -3 & & x = 1 \end{array}$$



3. Solve the equation  $x^2 + 6x + 8 = 0$

**Solution:**

This quadratic equation must be factorised first:

$$\begin{aligned}x^2 + 6x + 8 &= x^2 + 2x + 4x + 8 \\&= x(x + 2) + 4(x + 2) \\&= (x + 2)(x + 4)\end{aligned}$$

Therefore, we have  $(x + 2)(x + 4) = 0$

Either  $x + 2 = 0$  or  $x + 4 = 0$ . This gives  $x = -2$  and  $x = -4$

4. Solve the equation  $(x - 3)^2 = 0$

**Solution:**

Note that  $(x - 3)^2 = (x - 3)(x - 3)$ .

Setting this equal to 0,  $(x - 3)(x - 3) = 0$  implies that  $(x - 3) = 0$  twice.

There is only one solution,  $x = 3$ .

5. Solve the equation  $x(x + 3) = 0$ .

**Solution:**

Note that this is the quadratic equation  $x^2 + 3x = 0$ . This is a quadratic equation where  $c = 0$ . The 2 factors are  $x$  and  $(x + 3)$ .

This gives 2 solutions:

$$\begin{array}{l}x = 0 \qquad \text{or} \qquad x + 3 = 0 \\ \qquad \qquad \qquad \qquad \qquad \qquad x = -3\end{array}$$

The solution is  $x = 0, -3$

6. Solve  $3x^2 = 0$ .

**Solution:**

This is a quadratic equation where  $b = 0$  and  $c = 0$ .

Factorising the expression,  $3x^2 = 3(x)(x) = 0$ .

There is 1 solution:  $x = 0$ .

### Practice

1. Solve  $9x^2 = 0$

2. Solve  $8p(p + 2) = 0$

3. Solve  $(x - 7)(x + 2) = 0$

4. Solve the equation  $(y - 10)(y + 3) = 0$

5. Solve  $(x - 4)^2 = 0$

6. Solve  $(y - 6)^2 = 0$

7. Solve  $x(x - 12) = 0$

<b>Lesson Title:</b> Solving quadratic equations using factorisation	<b>Theme:</b> Algebraic Processes
<b>Practice Activity:</b> PHM1-L109	<b>Class:</b> SSS 1

	<p><b>Learning Outcome</b> By the end of the lesson, you will be able to use factorisation to solve quadratic equations.</p>
---	--

## Overview

A quadratic equation is of the form  $ax^2 + bx + c = 0$ , where  $a, b$ , and  $c$  are real numbers and  $a \neq 0$ .

Steps required for solving a quadratic equation by factoring:

**Step 1.** Write the equation in standard form, equal to zero.

**Step 2.** Factor the expression.

**Step 3.** Use the zero product property and set each factor containing a variable equal to zero.

**Step 4.** Solve each factor that was set equal to zero by getting the  $x$  on one side and the answer on the other side.

In using factorisation method to solve quadratic equations, the following should be considered when finding the factor pairs.

Questions	Answers
+ +	+ +
- +	- -
+ -	+ -
- -	+ - <b>or</b> - +

For example, if the standard equation has two positive signs, then the factor pairs should also follow with two positive signs; if it has a minus and a plus sign, then the factor pairs should follow with two negative signs, and so on.

## Solved Examples

1. Solve the quadratic equation:  $x^2 + 3x + 2 = 0$

**Solution:**

**Step 1.** Standard form

$$x^2 + 3x + 2 = 0$$

**Step 2.** Factorise

$$x^2 + x + 2x + 2 = 0$$

$$x(x + 1) + 2(x + 1) = 0$$

$$(x + 1)(x + 2) = 0$$

**Step 3.** Zero product property

Either  $x + 1 = 0$  or  $x + 2 = 0$

**Step 4.** Solve for  $x$

$$x = 0 - 1 \text{ or } x = 0 - 2$$

$$x = -1 \text{ or } -2$$

**Answer:**  $x = -1$  or  $-2$ .

Check:

Let  $x = -1$

$$x^2 + 3x + 2 = 0$$

$$(-1)^2 + 3(-1) + 2 = 0$$

$$1 - 3 + 2 = 0$$

$$0 = 0$$

**True**

Let  $x = -2$

$$x^2 + 3x + 2 = 0$$

$$(-2)^2 + 3(-2) + 2 = 0$$

$$4 - 6 + 2 = 0$$

$$0 = 0$$

**True**

2. Solve:  $3f^2 - 10f - 8 = 0$

**Solution:**

$$3f^2 - 10f - 8 = 0$$

Standard form

$$3f^2 + 2f - 12f - 8 = 0$$

Factorise

$$f(3f + 2) - 4(3f + 2) = 0$$

$$(3f + 2)(f - 4) = 0$$

Therefore, either:

$$3f + 2 = 0 \quad \text{or} \quad f - 4 = 0$$

Zero product property

$$3f = -2 \quad \quad \quad f = 4$$

Solve for  $f$

$$f = \frac{-2}{3}$$

**Answer:**  $f = \frac{-2}{3}, 4$

3. Solve the quadratic equation:  $2x^2 + x = 3$

**Solution:**

$$2x^2 + x - 3 = 0$$

Standard form

$$2x^2 + 3x - 2x - 3 = 0$$

Factorise

$$x(2x + 3) - 1(2x + 3) = 0$$

$$(2x + 3)(x - 1) = 0$$

Therefore, either:

$$2x + 3 = 0 \quad \text{or} \quad x - 1 = 0$$

Zero product property

$$2x = -3 \quad \quad \quad x = 1$$

Solve for  $x$

$$x = \frac{-3}{2}$$

**Answer:**  $x = \frac{-3}{2}, 1$

4. Solve  $3p^2 - 2p = 5$

Solution

$$3p^2 - 2p - 5 = 0$$

Standard form

$$3p^2 + 3p - 5p - 5 = 0$$

Factorise

$$3p(p + 1) - 5(p + 1) = 0$$

$$(3p - 5)(p + 1) = 0$$

Therefore, either:

$$3p - 5 = 0 \quad \text{or} \quad p + 1 = 0$$

Zero product property

$$3p = 5$$

$$p = \frac{5}{3}$$

$$p = -1$$

Solve for  $p$

**Answer:**  $p = \frac{5}{3}, -1$

### Practice

Solve the following quadratic equations:

1.  $y^2 + 9y + 14 = 0$
2.  $v^2 - 10v + 9 = 0$
3.  $2x^2 - 3x - 27 = 0$
4.  $10m^2 + 21m = 10$
5.  $7x^2 - 3x - 10 = 0$

<b>Lesson Title:</b> Finding a quadratic equation with given roots	<b>Theme:</b> Algebraic Processes
<b>Practice Activity:</b> PHM1-L110	<b>Class:</b> SSS 1

	<b>Learning Outcome</b> By the end of the lesson, you will be able to form a quadratic equation given its roots.
---	---

## Overview

We have factorised an equation to find its solutions, or roots. Now we are going to work backwards. Given the roots, we will write the equation. From the standard form of the equation, we have:

$$x^2 + bx + c = x^2 - (\text{sum of roots})x + (\text{product of roots}) = 0$$

In other words, for a quadratic equation in standard form, the sum of the roots gives  $b$ , and the product of the roots gives  $c$ .

## Solved Examples

1. Find the quadratic equation that has roots 2, 4.

**Solution:**

$$\begin{aligned} \text{Sum of roots} &= 2 + 4 = 6 \\ \text{Product of roots} &= 2 \times 4 = 8 \\ \text{Equation} \Rightarrow &x^2 - (6)x + (8) = 0 \\ &= x^2 - 6x + 8 = 0 \end{aligned}$$

2. Find the quadratic equation that has roots 3, 7.

**Solution:**

$$\begin{aligned} \text{Sum of roots} &= 3 + 7 = 10 \\ \text{Product of roots} &= 3 \times 7 = 21 \\ \text{Equation} \Rightarrow &x^2 - (10)x + (21) = 0 \\ &= x^2 - 10x + 21 = 0 \end{aligned}$$

3. Find the quadratic equation that has roots  $-3, -4$ .

**Solution:**

$$\begin{aligned} \text{Sum of roots} &= -3 + (-4) = -7 \\ \text{Product of roots} &= (-3) \times (-4) = 12 \\ \text{Equation} \Rightarrow &x^2 - (-7)x + (12) = 0 \\ &= x^2 + 7x + 12 = 0 \end{aligned}$$

4. Find the quadratic equation that has roots  $1, -\frac{3}{2}$ .

**Solution:**

$$\text{Sum of roots} = 1 + \left(-\frac{3}{2}\right)$$

$$= 1 - \frac{3}{2}$$

$$= -\frac{1}{2}$$

$$\text{Product of roots} = 1 \times \left(-\frac{3}{2}\right)$$

$$= -\frac{3}{2}$$

$$\text{Equation: } x^2 - \left(-\frac{1}{2}\right)x + \left(-\frac{3}{2}\right) = 0$$

$$x^2 + \frac{1}{2}x - \frac{3}{2} = 0$$

$$2x^2 + x - 3 = 0 \text{ multiply throughout by LCM of the denominators, 2}$$

5. Find the quadratic equation that has roots  $\frac{1}{2}, \frac{3}{2}$ .

**Solution:**

$$\text{Sum of roots} = \frac{1}{2} + \frac{3}{2}$$

$$= 2$$

$$\text{Product of roots} = \frac{1}{2} \times \frac{3}{2}$$

$$= \frac{3}{4}$$

$$\text{Equation: } x^2 - (2)x + \left(\frac{3}{4}\right) = 0$$

$$x^2 - 2x + \frac{3}{4} = 0$$

$$4x^2 - 8x + 3 = 0 \text{ multiply throughout by the LCM, 4}$$

## Practice

Find the quadratic equations that have the following roots:

1. 6, 4

2. -7, -2

3.  $4\frac{1}{2}, -3$

4. 2,  $-\frac{1}{2}$

5.  $\frac{2}{3}, \frac{4}{5}$

6.  $-1\frac{5}{7}, -1$

<b>Lesson Title:</b> Graphical solution of quadratic equations	<b>Theme:</b> Algebraic Processes
<b>Practice Activity:</b> PHM1-L111	<b>Class:</b> SSS 1

	<p><b>Learning Outcome</b> By the end of the lesson, you will be able to use graphical methods to solve quadratic equations.</p>
---	--

### Overview

The graphical method of solving a quadratic equation only gives an estimated solution(s). To solve a quadratic equation by graphing, draw the graph of the related function and observe its  $x$ -intercepts. The  $x$ -intercepts of a graph are the solutions of the equation. Consider the following examples:

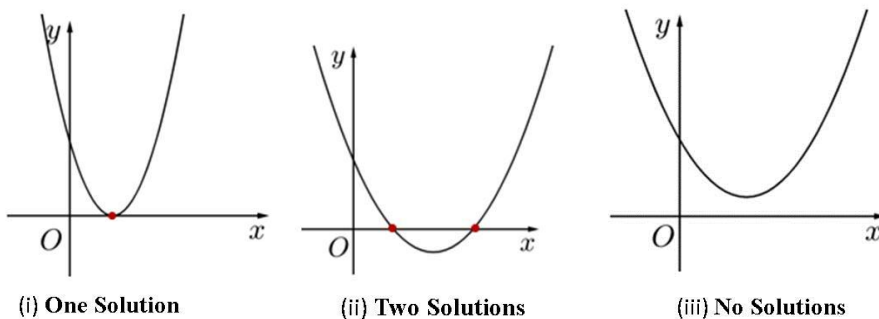

- In diagram (i), there is only one solution because the graph touches the  $x$ -axis at one point.
- In diagram (ii), there are two solutions because the graph touches the  $x$ -axis at two points.
- In diagram (iii), there is no real solution because the graph does not intersect with the  $x$ -axis.

Thus, a quadratic equation can have 0, 1 or 2 solutions.

### Solved Examples

- Given the quadratic equation  $y = -x^2 + x + 2$  for the interval  $-2 \leq x \leq 3$ , determine the corresponding values of  $y$ .
  - From the table of values of  $x$  and  $y$  plot the graph of  $y = -x^2 + x + 2$ .
  - From the graph find the solution set of the equation  $-x^2 + x + 2 = 0$ ?

**Solutions:**

- Graph the function using a table of values with  $x$ -values from  $-2$  to  $3$ :

$$\begin{aligned}
 y &= -(-2)^2 + (-2) + 2 \\
 &= -4 - 2 + 2 \\
 &= -4
 \end{aligned}$$

$x$	$-2$	$-1$	$0$	$1$	$2$	$3$
$y$	$-4$	$0$	$2$	$2$	$0$	$-4$

$$\begin{aligned} y &= -(-1)^2 + (-1) + 2 \\ &= -1 - 1 + 2 \\ &= 0 \end{aligned}$$

$$\begin{aligned} y &= -(2)^2 + (2) + 2 \\ &= -4 + 2 + 2 \\ &= 0 \end{aligned}$$

$$\begin{aligned} y &= -(0)^2 + (0) + 2 \\ &= 0 + 0 + 2 \\ &= 2 \end{aligned}$$

$$\begin{aligned} y &= -(3)^2 + (3) + 2 \\ &= -9 + 3 + 2 \\ &= -4 \end{aligned}$$

$$\begin{aligned} y &= -(1)^2 + (1) + 2 \\ &= -1 + 1 + 2 \\ &= 2 \end{aligned}$$

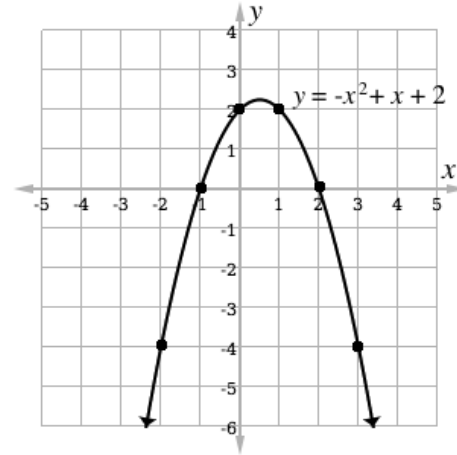

b. The solution set of the equation  $-x^2 + x + 2 = 0$  from the graph, consists of the  $x$ -values where the parabola crosses the  $x$ -axis,  $x = -1, 2$ .

2. Copy and complete the table below for the relation  $y + 3x^2 + 2x - 9 = 0$ .

$x$	-5	-4	-3	-2	-1	0	1	2	3
$y$	-56			1			4		

a. Using a scale of 2 cm to 1 unit on the  $x$ -axis and 2 cm to 10 units on the  $y$ -axis, draw the graph of  $y = -3x^2 - 2x + 9$

b. Use your graph to find the roots of the equation  $-3x^2 - 2x + 9 = 0$

### Solutions:

Graph the function by finding the missing  $x$ -values in the table

$$\begin{aligned} y &= -3(-4)^2 - 2(-4) + 9 \\ &= -48 + 8 + 9 \\ &= -31 \end{aligned}$$

$x$	-5	-4	-3	-2	-1	0	1	2	3
$y$	-56	-31	-12	1	8	9	4	-7	-24

$$\begin{aligned} y &= -3(-3)^2 - 2(-3) + 9 \\ &= -27 + 6 + 9 \\ &= -12 \end{aligned}$$

$$\begin{aligned} y &= -3(0)^2 - 2(0) + 9 \\ &= 0 - 0 + 9 \\ &= 9 \end{aligned}$$



$$\begin{aligned}
 y &= -3(-1)^2 - 2(-1) + 9 \\
 &= -3 + 2 + 9 \\
 &= 8
 \end{aligned}$$

$$\begin{aligned}
 y &= -3(2)^2 - 2(2) + 9 \\
 &= -12 - 4 + 9 \\
 &= -7
 \end{aligned}$$

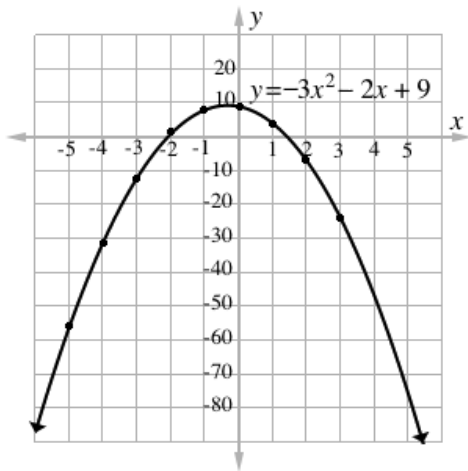

$$\begin{aligned}
 y &= -3(3)^2 - 2(3) + 9 \\
 &= -27 - 6 + 9 \\
 &= -24
 \end{aligned}$$

The roots of the quadratic equation  $-3x^2 - 2x + 9 = 0$  from the graph consists of the  $x$ -values where the parabola crosses the  $x$ -axis,  $x = -2.1$  and  $1.4$  (approximately).

### Practice

- Given the quadratic equation  $y = x^2 - 3x - 4$  for the interval  $-2 \leq x \leq 5$ , create a table of values with the corresponding values of  $y$ .
  - From the table of values of  $x$  and  $y$ , plot the graph of  $y = x^2 - 3x - 4$ .
  - From the graph, find the solution set of the equation  $x^2 - 3x - 4 = 0$ .
- Given the quadratic equation  $y = x^2 - 3x + 2$  for the interval  $-2 \leq x \leq 5$ , plot a graph of the equation on the given interval. From the graph, determine the roots of the equation  $x^2 - 3x + 2 = 0$ .
- Copy and complete the table below for the relation  $y = -6x^2 - 7x + 5$ .

$x$	-3	-2	-1	0	1
$y$	-28		6	5	

- Using a scale of 2 cm to 1 unit on the  $x$ -axis and 2 cm to 5 units on the  $y$ -axis, draw the graph of  $y = 5 - 7x - 6x^2$ .
  - Use your graph to find the roots of the equation  $5 - 7x - 6x^2 = 0$ .
- Copy and complete the table below for the relation  $y = x^2 + x - 2$ .

$x$	-4	-3	-2	-1	0	1	2	3
$y$	10				-2			

- Using a scale of 2 cm to 1 unit on the  $x$ -axis and 2 cm to 2 units on the  $y$ -axis, draw the graph of  $y = x^2 + x - 2$ .
- Use your graph to find the roots of the equation  $x^2 + x - 2 = 0$ .

<b>Lesson Title:</b> Finding an equation from a given graph	<b>Theme:</b> Algebraic Processes
<b>Practice Activity:</b> PHM1-L112	<b>Class:</b> SSS 1

	<p><b>Learning Outcome</b> By the end of the lesson, you will be able to form a quadratic equation from a given graph.</p>
---	--

### Overview

Remind pupils that any quadratic equation can be written as a function in the form  $y = ax^2 + bx + c$ .

To find the equation, we first need to find the roots from the graph. We need to estimate these points.

We will use the roots to find the equation. Use the roots to write the 2 binomial factors of the quadratic equation. Then, multiply them together and simplify.

### Solved Examples

1. Given the graph of a quadratic function shown below,
  - a. Determine the roots of the quadratic equation from the graph.
  - b. Form the quadratic function from the roots.

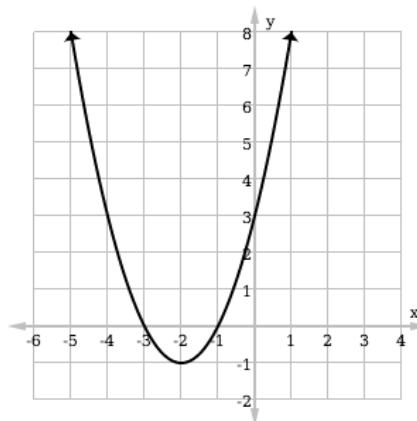

### Solutions:

- a. The roots of the quadratic equation shown in the graph are the x-values where the graph crosses the x-axis,  $x = -3$  and  $-1$ .
- b. If  $x = -3$  and  $x = -1$ , then find the 2 binomial factors:

$$\begin{array}{rclcl}
 x & = & -3 & \text{and} & x & = & -1 \\
 (x + 3) & = & 0 & & (x + 1) & = & 0
 \end{array}$$

Multiply the binomials together:

$$\begin{array}{rcl}
 (x + 3)(x + 1) & = & 0 \\
 (x^2 + x + 3x + 3) & = & 0
 \end{array}$$

$$x^2 + 4x + 3 = 0$$

Hence the function is  $f(x) = x^2 + 4x + 3$ .

2. Given the graph of a quadratic function shown below:
- Determine the roots of the quadratic equation from the graph.
  - Form the quadratic function from the roots.

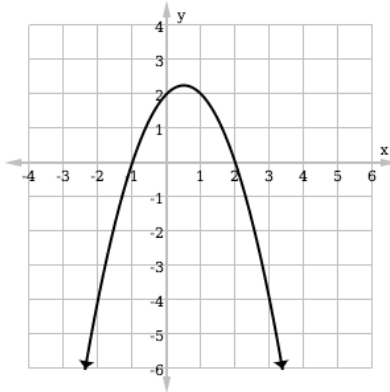

**Solutions:**

- The roots of the quadratic equation shown in the graph are the x-values where the graph crosses the x-axis.  $x = -1$  and  $2$ .
- If  $x = -1$  and  $x = 2$  then;

$$\begin{array}{rcl} x & = & -1 \\ (x + 1) & = & 0 \end{array} \quad \text{and} \quad \begin{array}{rcl} x & = & 2 \\ (x - 2) & = & 0 \end{array}$$

Multiply the 2 binomials:

$$\begin{aligned} (x + 1)(x - 2) &= 0 \\ (x^2 - 2x + x - 2) &= 0 \\ x^2 - x - 2 &= 0 \end{aligned}$$

Hence the function is  $f(x) = x^2 - x - 2$ .

3. Given the graph of a quadratic function shown below:
- Determine the roots of the quadratic equation from the graph.
  - Form the quadratic equation from the roots.

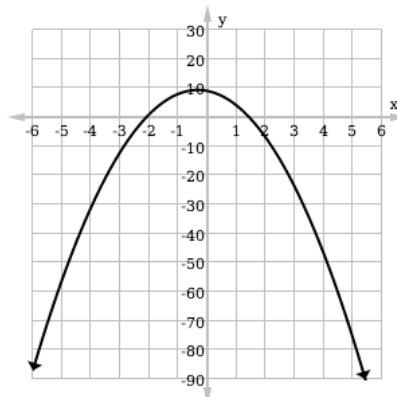

**Solutions:**

- a. The roots of the quadratic equation shown in the graph are the  $x$ -values where the graph crosses the  $x$ -axis. They are approximately  $x = -2.1$  and  $1.4$
- b. If  $x = -2.1$  and  $x = 1.4$  then:

$$\begin{array}{rcl} x & = & -2.1 \quad \text{and} \quad x = 1.4 \\ (x + 2.1) & = & 0 \quad \quad \quad (x - 1.4) = 0 \end{array}$$

Hence the equation is  $f(x) = x^2 - 0.7x - 2.94$ .

$$\begin{array}{rcl} (x + 2.1)(x - 1.4) & = & 0 \\ (x^2 + 2.1x - 1.4x - 2.94) & = & 0 \\ x^2 - 0.7x - 2.94 & = & 0 \end{array}$$

**Practice**

For each graph shown below, determine the roots and form the quadratic function.

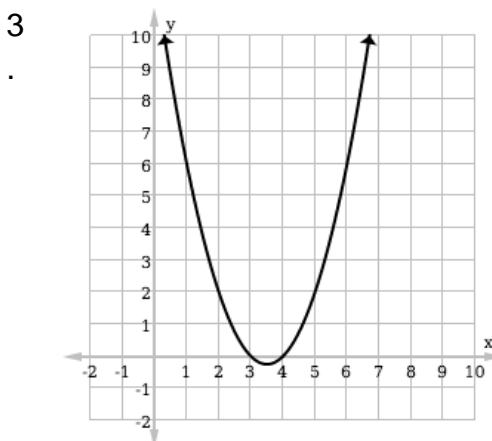
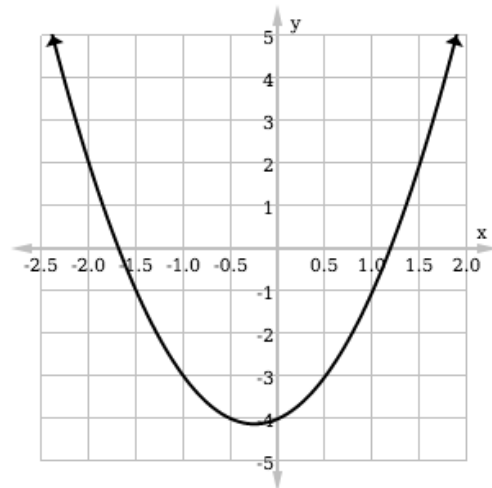
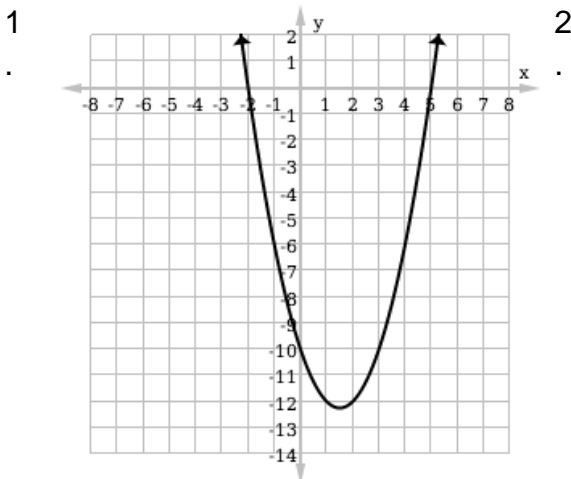

<b>Lesson Title:</b> Completing the Square and Perfect squares	<b>Theme:</b> Algebraic Processes
<b>Practice Activity:</b> PHM1-L113	<b>Class:</b> SSS 1



### Learning Outcome

By the end of the lesson, you will be able to solve quadratic equations by using perfect squares and completing the square.

### Overview

Consider the equation  $x^2 + 4x + 2 = 0$ . We cannot use the method we learnt to factorise this quadratic equation. We have to use a process called “completing the square” to solve this problem.

We start the lesson by expanding expressions such as  $(x + 2)^2$ . Such expressions are called perfect squares because they are squares of binomials. They are easy to expand and easy to factorise back into factors.

Completing the square changes, a quadratic expression to the sum of a perfect square and a number.

Compare  $x^2 + 4x + 2$  with the perfect square  $(x + 2)^2 = x^2 + 4x + 4$ . There is a difference of 2. Thus, we can rewrite  $x^2 + 4x + 2$  using the perfect square:

$$\begin{aligned} x^2 + 4x + 2 &= x^2 + 4x + 4 - 2 \\ &= (x + 2)^2 - 2 \end{aligned}$$

After completing the square, the expression can be solved for  $x$ . This gives the solutions, or roots, of the quadratic equation.

Generally, every imperfect square in the form  $ax^2 + bx + c$  can be written as  $ax^2 + bx + c = (x + m)^2 + n$  where  $m$  and  $n$  are constants.  $ax^2 + bx + c = x^2 + 2mx + m^2 + n$  gives formulae:  $m = \frac{b}{2}$  and  $m^2 + n = \frac{c}{a}$ . These can be used to complete the square by finding  $m$  and  $n$ .

### Solved Examples

1. Find the roots of  $x^2 + 4x + 3 = 0$  by completing the square.

#### Solution:

Note that in this equation,  $a = 1$ ,  $b = 4$  and  $c = 3$ .

$x^2 + 4x + 3$  is an imperfect square, so write in the form:

$$x^2 + 4x + 3 = (x + m)^2 + n$$

$$x^2 + 4x + 3 = x^2 + 2mx + m^2 + n$$

Set the second term,  $2mx$ , equal to  $b$  and solve for  $m$ . Alternatively, use the formula  $m = \frac{b}{2}$ .

$$4 = 2m$$

$$\frac{4}{2} = \frac{2m}{2}$$

$$2 = m$$

Set the constant terms equal and solve for  $n$ :

$$3 = m^2 + n$$

$$3 = 2^2 + n$$

$$3 = 4 + n$$

$$3 - 4 = n$$

$$-1 = n$$

Substitute  $m = 2$  and  $n = -1$  into the formula,  $(x + m)^2 + n$ .

$$\begin{aligned}x^2 + 4x + 3 &= (x + m)^2 + n = 0 \\ &= (x + 2)^2 - 1 = 0\end{aligned}$$

Solve for  $x$ :

$$(x + 2)^2 - 1 = 0$$

$$(x + 2)^2 = 1$$

$$\sqrt{(x + 2)^2} = \sqrt{1}$$

$$x + 2 = \pm 1$$

$$x = -2 \pm 1$$

$$\text{Either } x = -2 + 1 = -1$$

$$\text{Or } x = -2 - 1 = -3$$

Therefore, the roots of  $x^2 + 4x + 3 = 0$  are  $x = -1, -3$ .

2. Find the roots of quadratic equation by completing the square:  $x^2 + 5x - 2 = 0$

**Solution:**

To complete the square, write  $x^2 + 5x - 2$  in the form  $(x + m)^2 + n$ . Now you have  $x^2 + 5x - 2 = (x + m)^2 + n = x^2 + 2mx + m^2 + n$

Set the second term,  $2mx$ , equal to  $b$  and solve for  $m$ .

$$5 = 2m$$

$$\frac{5}{2} = m$$

Set the constant terms equal and solve for  $n$ :

$$-2 = m^2 + n$$

$$-2 = \left(\frac{5}{2}\right)^2 + n$$

$$-2 = \frac{25}{4} + n$$

$$-2 - \frac{25}{4} = n$$

$$-\frac{33}{4} = n$$

Substitute  $m = \frac{5}{2}$  and  $n = -\frac{33}{4}$  into the formula,  $(x + m)^2 + n$ .

$$\begin{aligned}x^2 + 5x - 2 &= (x + m)^2 + n = 0 \\ &= \left(x + \frac{5}{2}\right)^2 - \frac{33}{4} = 0\end{aligned}$$

Solve for  $x$ :

$$\begin{aligned} \left(x + \frac{5}{2}\right)^2 - \frac{33}{4} &= 0 \\ \left(x + \frac{5}{2}\right)^2 &= \frac{33}{4} \\ x + \frac{5}{2} &= \pm\sqrt{\frac{33}{4}} \\ x &= -\frac{5}{2} \pm \sqrt{\frac{33}{4}} \\ \text{Either } x &= -\frac{5}{2} + \frac{\sqrt{33}}{2} = \frac{-5+\sqrt{33}}{2} \\ \text{Or } x &= -\frac{5}{2} - \frac{\sqrt{33}}{2} = \frac{-5-\sqrt{33}}{2} \end{aligned}$$

3. Writing  $x^2 + 8x + 6$  in the form  $(x + m)^2 + n$  find the value of  $m$  and  $n$  and hence solve the equation  $x^2 + 8x + 6 = 0$ .

**Solution:**

Writing  $x^2 + 8x + 6$  in the form  $(x + m)^2 + n$  we have

$$x^2 + 8x + 6 = (x + m)^2 + n = x^2 + 2mx + m^2 + n$$

Solving for  $m$  and  $n$ , we have:

$$\begin{aligned} 8 &= 2m & 6 &= m^2 + n \\ m &= \frac{8}{2} & 6 &= 4^2 + n \\ &= 4 & 6 &= 16 + n \\ & & n &= 6 - 16 \\ & & &= -10 \end{aligned}$$

Hence  $x^2 + 8x + 6 = (x + 4)^2 - 10$ . Therefore, solve for  $x$ :

$$\begin{aligned} (x + 4)^2 - 10 &= 0 \\ (x + 4)^2 &= 10 \\ x + 4 &= \pm\sqrt{10} \\ x &= -4 \pm \pm\sqrt{10} \\ \text{Either } x &= -4 + \sqrt{10} \\ \text{Or } x &= -4 - \sqrt{10} \end{aligned}$$

**Practice**

- Find the roots of  $3x^2 - 8x + 2 = 0$  using completing the square method.
- Find the roots of the quadratic equation by completing the square:  $2x^2 - 10x + 7 = 0$ .
- Writing  $x^2 + 4x - 5$  in the form  $(x + m)^2 + n$ , determine the values of  $m$  and  $n$  and hence solve the equation  $x^2 + 4x - 5 = 0$
- Find the root of the quadratic equations by completing the square:
  - $6x^2 + 13x + 6 = 0$
  - $2a^2 + 7a - 3 = 0$
  - $4y^2 + 7y - 2 = 0$

<b>Lesson Title:</b> The quadratic formula	<b>Theme:</b> Algebraic Processes
<b>Practice Activity:</b> PHM1-L114	<b>Class:</b> SSS 1



### Learning Outcome

By the end of the lesson, you will be able to solve quadratic equations using the quadratic formula.

### Overview

In addition to factoring and completing the square, there is another method you can use to find the roots of a quadratic equation. This is called the quadratic formula, and is useful when the quadratic expression cannot be easily factorised.

The quadratic formula is  $x = \frac{-b \pm \sqrt{b^2 - 4ac}}{2a}$

This formula is derived from the general form of quadratic equation  $ax^2 + bx + c = 0$  using the completing the square method.

In solving problems using the formula, you have to write down the values of  $a$ ,  $b$  and  $c$  and substitute these values into the formula to find the roots of the equation.

### Solved Examples

1. Use the quadratic formula to solve:  $x^2 + 13x + 22 = 0$

#### Solution:

Note that  $a = 1, b = 13, c = 22$ . Substitute these values and evaluate:

$$\begin{aligned}
 x &= \frac{-b \pm \sqrt{b^2 - 4ac}}{2a} && \text{Formula} \\
 &= \frac{-13 \pm \sqrt{13^2 - (4)(1)(22)}}{2(1)} && \text{Substitute } a = 1, b = 13, c = 22 \\
 &= \frac{-13 \pm \sqrt{169 - 88}}{2} && \text{Evaluate} \\
 &= \frac{-13 \pm \sqrt{81}}{2} \\
 &= \frac{-13 \pm 9}{2} \\
 x &= \frac{-13+9}{2} \text{ or } \frac{-13-9}{2} \\
 &= -\frac{4}{2} \text{ or } \frac{-22}{2} \\
 &= -2 \text{ or } -11
 \end{aligned}$$

2. Use the quadratic equation to solve:  $x^2 + 16x + 64 = 0$

#### Solution:

Note that  $a = 1, b = 16, c = 64$ .

$$x = \frac{-b \pm \sqrt{b^2 - 4ac}}{2a}$$



$$\begin{aligned}
&= \frac{-16 \pm \sqrt{16^2 - (4)(1)(64)}}{2(1)} \\
&= \frac{-16 \pm \sqrt{256 - 256}}{2} \\
&= \frac{-16 \pm \sqrt{0}}{2} \\
&= \frac{-16 \pm 0}{2} \\
x &= \frac{-16 + 0}{2} = -\frac{16}{2} = -8 \\
&\text{or} \\
x &= \frac{-16 - 0}{2} = -\frac{16}{2} = -8
\end{aligned}$$

There is one solution,  $x = -8$  twice.

3. Use the quadratic equation formula to solve:  $y^2 - 9y + 14 = 0$

**Solution:**

Note that  $a = 1, b = -9, c = 14$ .

$$\begin{aligned}
y &= \frac{-b \pm \sqrt{b^2 - 4ac}}{2a} \\
&= \frac{-(-9) \pm \sqrt{(-9)^2 - (4)(1)(14)}}{2(1)} \\
&= \frac{9 \pm \sqrt{81 - 56}}{2} \\
&= \frac{9 \pm \sqrt{25}}{2} \\
y &= \frac{9+5}{2} \text{ or } \frac{9-5}{2} \\
&= \frac{14}{2} \text{ or } \frac{4}{2} \\
&= 7 \text{ or } 2
\end{aligned}$$

4. Use the quadratic equation formula to solve:  $5m^2 - 2m - 3 = 0$

**Solution:**

Note that  $a = 5, b = -2, c = -3$ .

$$\begin{aligned}
m &= \frac{-b \pm \sqrt{b^2 - 4ac}}{2a} \\
&= \frac{-(-2) \pm \sqrt{(-2)^2 - (4)(5)(-3)}}{2(5)} \\
&= \frac{2 \pm \sqrt{4 + 60}}{10} \\
&= \frac{2 \pm \sqrt{64}}{10} \\
m &= \frac{2+8}{10} \text{ or } \frac{2-8}{10} \\
&= \frac{10}{10} \text{ or } -\frac{6}{10} \\
&= 1 \text{ or } -\frac{3}{5}
\end{aligned}$$

5. Solve  $7y^2 - 3y - 10 = 0$  using the quadratic formula.

**Solution:**

Note that  $a = 7, b = -3, c = -10$ .

$$\begin{aligned}
y &= \frac{-b \pm \sqrt{b^2 - 4ac}}{2a} \\
&= \frac{-(-3) \pm \sqrt{(-3)^2 - (4)(7)(-10)}}{2(7)} \\
&= \frac{3 \pm \sqrt{9 + 280}}{14} \\
&= \frac{3 \pm \sqrt{289}}{14} \\
y &= \frac{3+17}{14} \text{ Or } \frac{3-17}{14} \\
&= \frac{20}{14} \text{ Or } -\frac{14}{14} \\
&= \frac{10}{7} \text{ or } -1
\end{aligned}$$

### Practice

Use quadratic formula to solve the following quadratic equations:

1.  $y^2 + 12y + 11 = 0$
2.  $x^2 - 16x + 28 = 0$
3.  $m^2 - 5m = 6$
4.  $4n^2 - 12n + 9 = 0$
5.  $x^2 + 21x + 108 = 0$
6.  $11y^2 - 18y - 8 = 0$
7.  $2x^2 + x - 1 = 0$
8.  $4p^2 + 38p - 20 = 0$
9.  $4m^2 - 17m + 18 = 0$

<b>Lesson Title:</b> Word problems leading to quadratic equations	<b>Theme:</b> Algebraic Processes
<b>Practice Activity:</b> PHM1-L115	<b>Class:</b> SSS 1

	<p><b>Learning Outcome</b> By the end of the lesson, you will be able to form and solve word problems by forming and solving suitable quadratic equations.</p>
---	--

## Overview

This lesson is on forming quadratic equations from word problems. Word problems which involve relations among known and unknown numbers can lead to quadratic equations.

To solve quadratic equations with word problems you follow the following steps:

- Read the problem carefully and note what is given and what is required.
- Assign a variable to represent the unknown.
- Identify any value/constant that is multiplied by the variable (the coefficient).
- Identify any value that is a constant.
- Write the quadratic expression representing the situation.
- Solve the equation for the unknown variable.
- Verify whether the answer satisfy the condition of the problem.

## Solved Examples

1. The sum of two numbers is 15 and their product is 54. Determine the value of the numbers.

**Solution:**

Let one of the numbers be  $x$  and the other be  $y$ . Then we can write 2 equations:

Sum of the number  $x + y = 15$

Product of the number  $xy = 54$

Changing the subject of the first equation, we have  $y = 15 - x$ .

Substituting in  $xy = 54$  we have:

$$x(15 - x) = 54$$

$$15x - x^2 = 54$$

$$x^2 - 15x + 54 = 0$$

Solve the quadratic equation by factorisation:

$$x^2 - 15x + 54 = 0$$

$$x^2 - 6x - 9x + 54 = 0$$

$$x(x - 6) - 9(x - 6) = 0$$

$$(x - 9)(x - 6) = 0$$

Either  $x - 9 = 0$  or  $x - 6 = 0$

$$x = 9 \qquad x = 6$$

Substitute both values of  $x$  into  $y = 15 - x$  to find the corresponding  $y$ -value:

When  $x = 9$ ,  $y = 15 - 9 = 6$

$$x = 6, \quad y = 15 - 6 = 9$$

Therefore,  $x = 9, y = 6$  or  $x = 6, y = 9$ .

2. The sum of a number and its square is 20. Find the number.

**Solution:**

Let the number be  $n$

Sum of  $n$  and its square  $n + n^2 = 20$

Rearranging we have  $n^2 + n - 20 = 0$

Solve using the quadratic formula,  $n = \frac{-b \pm \sqrt{b^2 - 4ac}}{2a}$ .

For  $a = 1, b = 1$  and  $c = -20$  we have:

$$\begin{aligned} n &= \frac{-1 \pm \sqrt{(1)^2 - 4(1)(-20)}}{2 \times 1} \\ &= \frac{-1 \pm \sqrt{1+80}}{2} \\ &= \frac{-1 \pm \sqrt{81}}{2} \\ &= \frac{-1 \pm 9}{2} \end{aligned}$$

Either  $n = \frac{-1+9}{2} = \frac{8}{2} = 4$  or  $n = \frac{-1-9}{2} = \frac{-10}{2} = -5$

The answers are  $n = 4, -5$ .

3. A woman is 4 times older than her daughter, and 6 years ago the product of their ages was 136. Find their present ages.

**Solution:**

Present age:

Let age of daughter be  $x$  years

Woman's age =  $4x$

6 years ago:

Age of daughter  $(x - 6)$  years

Age of woman  $(4x - 6)$

Product of their ages 6 years ago:

$$(x - 6)(4x - 6) = 136$$

$$4x^2 - 6x - 24x + 36 = 136$$

$$4x^2 - 30x + 36 - 136 = 0$$

$$4x^2 - 30x - 100 = 0$$

Solve using the quadratic formula,  $x = \frac{-b \pm \sqrt{b^2 - 4ac}}{2a}$ .

Using  $x = 4, b = -30$  and  $c = -100$ , we have:

$$n = \frac{-(-30) \pm \sqrt{(-30)^2 - 4(4)(-100)}}{2 \times 4}$$

$$\begin{aligned}
&= \frac{30 \pm \sqrt{900 + 1600}}{8} \\
&= \frac{30 \pm \sqrt{2500}}{8} \\
&= \frac{30 \pm 50}{8}
\end{aligned}$$

Either  $x = \frac{30+50}{8} = \frac{80}{8} = 10$  years      or  $x = \frac{30-50}{8} = \frac{-20}{8}$  (not possible)

Present age of daughter:  $x = 10$  years

Present age of woman:  $4x = 4 \times 10 = 40$  years

4. Two times a certain whole number taken from 3 times the square of the number results in 133. Find the number.

**Solution:**

Let the number be  $t$ . Two times  $t$  is  $2t$ . Three times the square of  $t$  is  $3t^2$ .

The equation from the problem is  $3t^2 - 2t = 133$ .

In standard form, this becomes  $3t^2 - 2t - 133 = 0$ .

Solve for  $t$  using the quadratic formula,  $t = \frac{-b \pm \sqrt{b^2 - 4ac}}{2a}$ .

Note that  $a = 3, b = -2$  and  $c = -133$ .

$$\begin{aligned}
t &= \frac{-(-2) \pm \sqrt{(-2)^2 - 4(3)(-133)}}{2 \times 3} \\
&= \frac{2 \pm \sqrt{4 + 1596}}{6} \\
&= \frac{2 \pm \sqrt{1600}}{6} \\
&= \frac{2 \pm 40}{6}
\end{aligned}$$

Either  $t = \frac{2+40}{6} = \frac{42}{6} = 7$     Or     $t = \frac{2-40}{6} = -\frac{38}{6} = -6\frac{1}{3}$

**Practice**

- Two numbers have a difference of 3 and the sum of their squares is 89. Find the numbers.
- The square of a number is 22 less than 13 times the original number. Find the number.
- The ages of two boys are 11 and 8 years. In how many years' time will the product of their ages be 208?
- A certain number is taken from 18 and from 13. The product of the two numbers obtained after subtracting is 66. Find the number.
- The length of one side of a rectangle is two times the length of the other side. If the area of the rectangle is  $162 \text{ cm}^2$ . What are the dimensions of the rectangle?

<b>Lesson Title:</b> Practice of quadratic equations	<b>Theme:</b> Algebraic Processes
<b>Practice Activity:</b> PHM1-L116	<b>Class:</b> SSS 1

 <b>Learning Outcome</b> By the end of the lesson, you will be able to apply various methods in solving quadratic equations.
--

## Overview

Quadratic equation can be solved using the following methods:

- Factorisation where possible.
- Completing the square on the quadratic expression by writing it in the form  $(x + m)^2 + n$ . That is, given a quadratic equation  $ax^2 + bx + c = 0$ , we can write  $x^2 + \frac{bx}{a} + \frac{c}{a}$  in the form  $(x + m)^2 + n$ .
- The general quadratic formula. Given the equation  $ax^2 + bx + c = 0$ , the formula is  $x = \frac{-b \pm \sqrt{b^2 - 4ac}}{2a}$ .
- Graphing the parabola and identifying any points where the curve intersects with the  $x$ -axis as the solutions.

## Solved Examples

1. Use the method of factorisation to solve the quadratic equations:

a.  $2x^2 + 3x + 1 = 0$

b.  $y^2 + 13y + 30 = 0$

**Solutions:**

a.  $2x^2 + 3x + 1 = 0$

$$2x^2 + 2x + x + 1 = 0$$

$$2x(x + 1) + 1(x + 1) = 0$$

$$(2x + 1)(x + 1) = 0$$

Either  $2x + 1 = 0$

$$x = -\frac{1}{2}$$

Or  $x + 1 = 0$

$$x = -1$$

b.  $y^2 + 13y + 30 = 0$

$$y^2 + 10y + 3y + 30 = 0$$

$$y(y + 10) + 3(y + 10) = 0$$

$$(y + 3)(y + 10) = 0$$

Either  $y + 3 = 0$

$$y = -3$$

Or  $y + 10 = 0$

$$y = -10$$

2. Find the roots of the quadratic equation by completing the square:

$$x^2 + 9x + 19 = 0.$$

**Solution:**

Writing  $x^2 + 9x + 19$  in the form  $(x + m)^2 + n$  we have

$$x^2 + 9x + 19 = (x + m)^2 + n$$

$$= x^2 + 2mx + m^2 + n$$

Comparing coefficients we have:

$$\begin{aligned}
2m &= -9 & 19 &= m^2 + n \\
m &= -\frac{9}{2} & 19 &= \left(-\frac{9}{2}\right)^2 + n \\
& & 19 &= \frac{81}{4} + n \\
& & n &= +\frac{19}{1} - \frac{81}{4} = \frac{+76-81}{4} \\
& & &= -\frac{5}{4}
\end{aligned}$$

Hence  $x^2 + 9x + 19 = 0$

$$\left(x - \frac{9}{2}\right)^2 - \frac{5}{4} = 0$$

$$\left(x - \frac{9}{2}\right)^2 = \frac{5}{4}$$

$$\left(x + \frac{9}{2}\right) = \pm \sqrt{\frac{5}{4}}$$

$$x = \frac{9}{2} \pm \sqrt{\frac{5}{4}}$$

Either  $x = \frac{9}{2} + \frac{\sqrt{5}}{2} = \frac{9+\sqrt{5}}{2}$

Or  $x = \frac{9}{2} - \frac{\sqrt{5}}{2} = \frac{9-\sqrt{5}}{2}$

3. Use the quadratic formula to solve  $3x^2 + 6x - 5 = 0$ .

**Solution:**

Comparing the equation to the general quadratic equation  $ax^2 = bx + c = 0$

We have  $x = \frac{-b \pm \sqrt{b^2 - 4ac}}{2a}$

For  $3x^2 + 6x - 5 = 0$

$a = 3, b = 6, c = -5$

$$\begin{aligned}
\text{So } x &= \frac{-6 \pm \sqrt{6^2 - 4(3)(-5)}}{2 \times 3} \\
&= \frac{-6 \pm \sqrt{36 + 60}}{6} = \frac{-6 \pm \sqrt{96}}{6} = \frac{-6 \pm 4\sqrt{6}}{6}
\end{aligned}$$

Either  $x = -1 + \frac{2}{3}\sqrt{6} = 0.63$

Or  $x = -1 - \frac{2}{3}\sqrt{6} = -2.63$

4. Complete the table below and use it to graph the function  $y = x^2 + 2x - 8$ .

$x$	-5	-4	-3	-2	-1	0	1	2	3
$y$			-5	-8			-5		7

Identify the following:

- The solutions of  $x^2 + 2x - 8 = 0$
- The minimum
- The line of symmetry

**Solution:**

Complete the table of values for  $y = x^2 + 2x - 8$ :

$x$	-5	-4	-3	-2	-1	0	1	2	3
$y$	7	0	-5	-8	-9	-8	-5	0	7

Draw the graph:

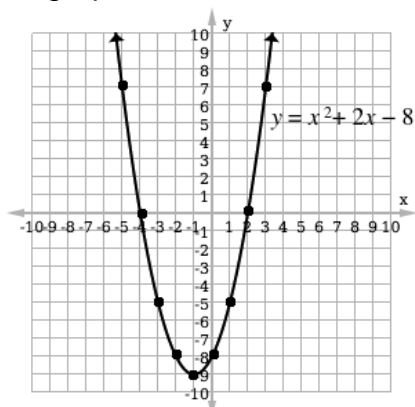

- The solutions are the  $x$ -intercepts,  $x = -4, 2$
- The minimum is  $(-1, -9)$
- The line of symmetry is  $x = -1$

5. Find the quadratic function that has roots  $-5$  and  $-\frac{3}{4}$ .

**Solution:**

For roots  $-5$  and  $-\frac{3}{4}$  we have:

$$\text{sum of roots} = -5 - \frac{3}{4} = \frac{-23}{4} \qquad \text{Product of roots} = (-5)\left(-\frac{3}{4}\right) = \frac{15}{4}$$

The general form of a quadratic equation with given roots is:

$$x^2 - (\text{sum of roots})x + (\text{product of roots}) = 0$$

$$x^2 - \left(-\frac{23}{4}\right)x + \frac{15}{4} = 0$$

$$4x^2 + 23x + 15 = 0 \qquad \text{(Multiplying through by 4)}$$

### Practice

- Solve the following quadratic equation by factorisation:
  - $13y^2 - 2y - 5 = 8y^2 - 2$
  - $3a^2 - 14a + 13 = 3 - a$
- Determine the roots of the quadratic equations by completing the square:
  - $x^2 - 5x - 14 = 0$
  - $x^2 - 9x + 14 = 0$
- Using the quadratic formula to solve the quadratic equations:
  - $2x^2 + 3x + 1 = 0$
  - $u^2 + 21u + 108 = 0$
- Copy and complete the table of values below for  $y = x^2 + 5x + 4$ . Use graphing to solve the quadratic equation  $x^2 + 5x + 4 = 0$ .

$x$	-6	-5	-4	-3	-2	-1	0	1
$y$								

5. Form the quadratic equation with roots  $\frac{2}{3}$  and  $\frac{4}{5}$ .



<b>Lesson Title:</b> The degree as a unit of measure	<b>Theme:</b> Geometry
<b>Practice Activity:</b> PHM1-L117	<b>Class:</b> SSS 1

	<p><b>Learning Outcomes</b></p> <p>By the end of the lesson, you will be able to:</p> <ol style="list-style-type: none"> <li>1. Define the degree as a unit of measure.</li> <li>2. Describe how degree measurements are utilised in everyday life.</li> <li>3. Use a protractor to measure angles.</li> </ol>
---	--

**Overview**

An angle is made up of 2 lines. The corner point of an angle is called the vertex and the two straight lines are called rays. For example,  $\angle ABC$  (“angle ABC”) is shown below. It can be measured in degrees. Degrees are used to measure turn. There are 360 degrees in one full rotation (one complete circle). We use little circle ( $^{\circ}$ ) following the number to mean degrees.

In this case,  $\angle ABC = 105^{\circ}$

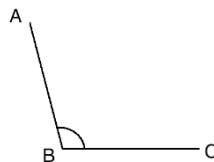

You can use a protractor to measure angles. If you do not have a protractor, you can make one with paper. Trace this protractor with a pen onto another piece of paper.

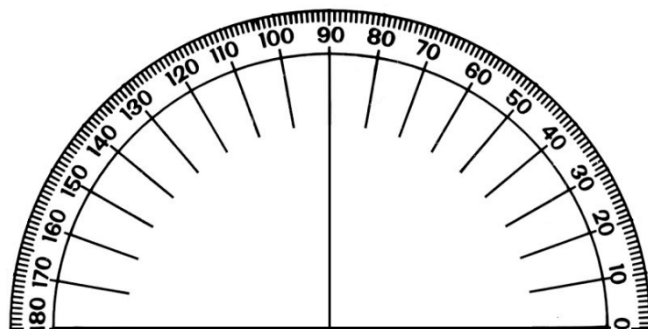

To measure an angle, place a protractor over one ray so that its centre O is exactly over the vertex of the angle and the baseline is exactly along one line of the angle.

The angle shown here opens on the left. In this case, count the degrees using the outside numbers, starting on the left, from the baseline to where the other ray of the angle is pointing. The angle shown here is  $50^{\circ}$ .

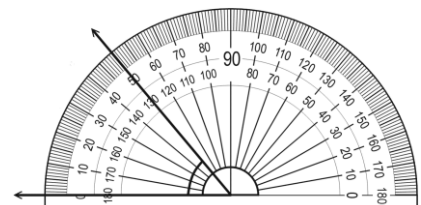

There are many real-world situations and professions that use angles. For example:

- In construction, angles are used to make buildings stable and sturdy. For example, the roof of a house has to be at least  $39^{\circ}$  and at a maximum  $48^{\circ}$  to prevent rain water and make sure the rain can slide off.

- Carpenters use angles. For example, in making a book shelf, you would have to make sure the corner angles are all the same and to do that you'd have to find the degrees of all the angles.
- Another place where angles are used is in football, not so much to do with the ball but the pitch itself. For example, the corner flag is  $90^\circ$ .
- In engineering the precise angle is required. For example, the wings of an airplane must be exactly angled at  $15^\circ$  upwards or otherwise the airflow over the wing will be compromised.

### Solved Examples

1. a. Write the following angular measurements in words:

- $104^\circ$
- $16.3^\circ$

b. Write the following angular measurements in figures:

- Three hundred twenty point three degrees
- Ten and a half degrees

#### Solutions:

- One hundred and four degrees
  - Sixteen point three degrees
- $320.3^\circ$
  - $10.5^\circ$

2. Give the values of the angles illustrated in the measurements below.

a

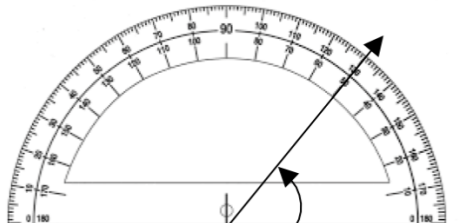

b

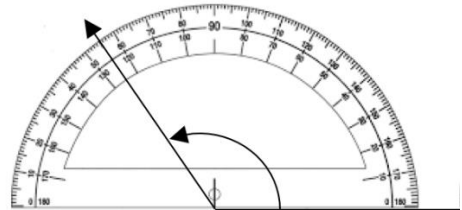

c.

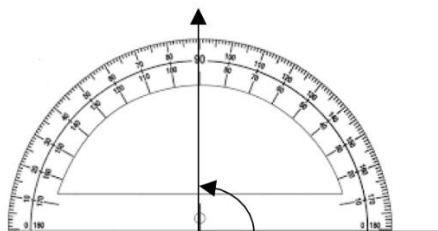

#### Solutions:

- a.  $50^\circ$     b.  $125^\circ$     c.  $90^\circ$

3. Use a protractor to measure the following angles:

a.

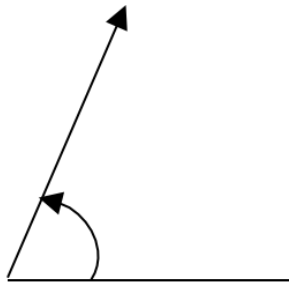

b.

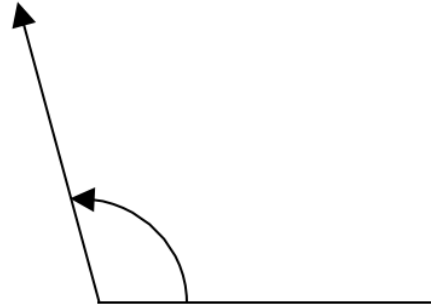

c.

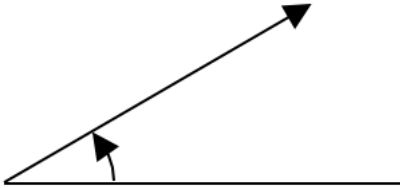

**Solutions:**

a.  $67^\circ$     b.  $105^\circ$     c.  $30^\circ$

**Practice**

- Write the following angular measurements in words:
  - $280^\circ$
  - $80.39^\circ$
  - $16.5^\circ$
- Write the following angular measurements in figures:
  - Fifty-five degrees
  - Sixty-six degrees and half degrees.
  - Ninety point four degrees.
- Read the values of the following angles illustrated in the measurements below:

a.

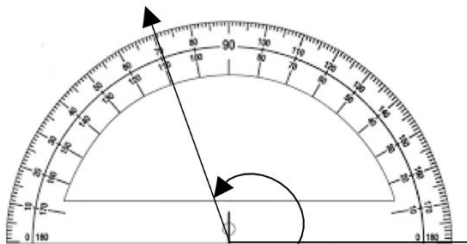

b.

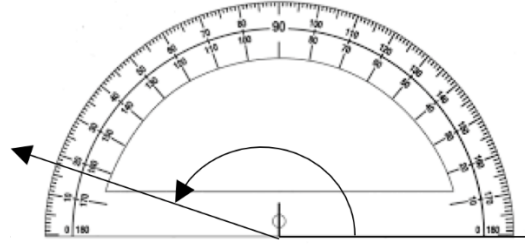

c.

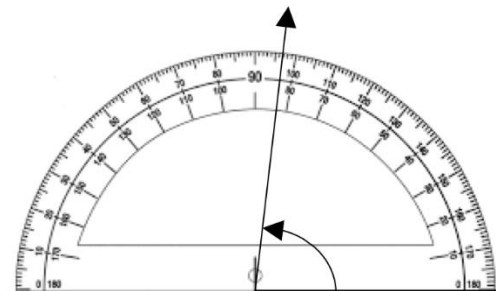

<b>Lesson Title:</b> Acute, obtuse, right, reflex, and straight angles	<b>Theme:</b> Geometry
<b>Practice Activity:</b> PHM1-L118	<b>Class:</b> SSS 1



### Learning Outcomes

By the end of the lesson, you will be able to:

1. Identify and describe acute, obtuse, right, reflex, and straight angles.
2. Classify angles as acute, obtuse, right, reflex, or straight.

### Overview

An angle measures the amount of turn. The different types of angles are shown and described below:

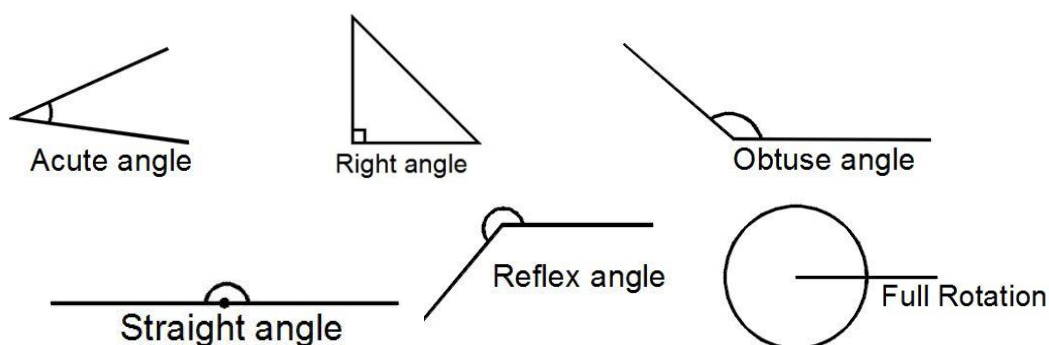

- Acute angle is an angle less than  $90^\circ$ .
- Right angle is an angle that is exactly  $90^\circ$ .
- Obtuse angle is an angle that is greater than  $90^\circ$  but less than  $180^\circ$ .
- Straight angle is an angle that is exactly  $180^\circ$ .
- Reflex angle is an angle greater than  $180^\circ$  but less than  $360^\circ$ .
- Full rotation is exactly  $360^\circ$ .

### Solved Examples

1. Classify the types of angles listed below:

- $3^\circ$
- $69^\circ$
- $170^\circ$
- $239^\circ$
- $179^\circ$

#### Solutions:

a. Acute angle; b. Acute angle; c. Obtuse angle; d. Reflex angle; e. Obtuse angle.

2. Label each angle as an acute, right, obtuse, straight or reflex angle:

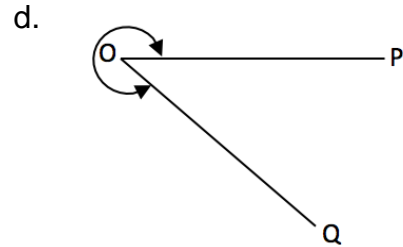
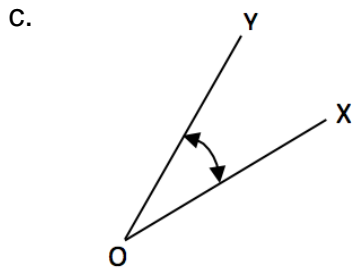
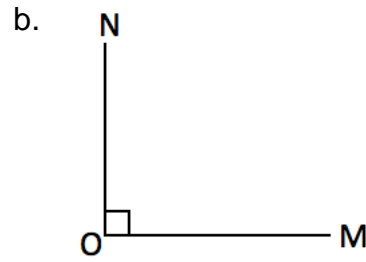
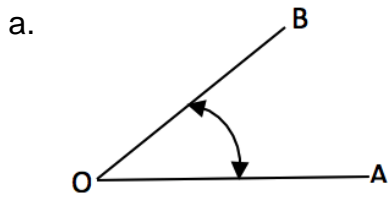

**Solutions:**

a. Acute angle; b. Right angle; c. Acute angle; d. Reflex angle.

**Practice**

1. Classify the types of angles listed below:

- a.  $33^\circ$
- b.  $109^\circ$
- c.  $359^\circ$
- d.  $183^\circ$
- e.  $275^\circ$
- f.  $101^\circ$

2. Label each angle as an acute, right, obtuse straight or reflex angle:

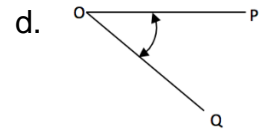
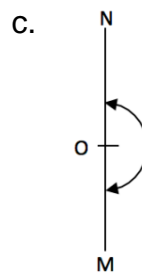
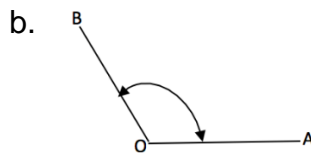
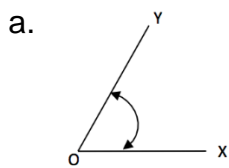

<b>Lesson Title:</b> Drawing of angles with specific measure	<b>Theme:</b> Geometry
<b>Practice Activity:</b> PHM1-L119	<b>Class:</b> SSS 1

 <b>Learning Outcome</b> By the end of the lesson, you will be able to draw angles with specific measurements.
--

## Overview

Recall the following angles:

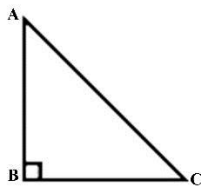

**Right angle**  
90 degrees

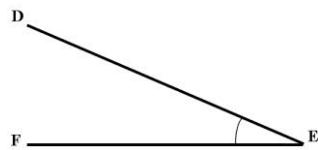

**Acute angle**  
less than 90 degrees

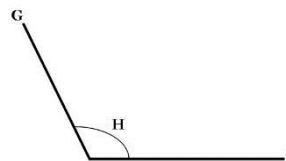

**Obtuse angle**  
more than 90 degrees

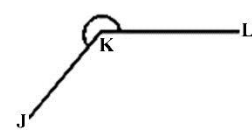

**Reflex angle**  
more than 180 degrees

We can use a protractor to draw each type of angle. See the solved example 1 for step-by-step instructions for drawing an angle.

## Solved Examples

1. Draw an obtuse angle  $GHI$  with measure  $120^\circ$ .

**Solution:**

**Step 1.** Draw a base line

**Step 2.** Place a protractor on the base line so that its centre 0, is exactly over the vertex of the angle and the base line is exactly along one line of the angle.

**Step 3.** Since the angle opens on the right, identify  $120^\circ$  from the numbers that start on the right, from the base line to where the other ray of the angle is pointing. These numbers are typically the inside set of numbers on a protractor.

**Step 4.** Mark  $120^\circ$  on your paper. Remove the protractor, and use a straight edge to connect the  $120^\circ$  mark to the vertex of the angle.

This angle is  $\angle GHI = 120^\circ$ .

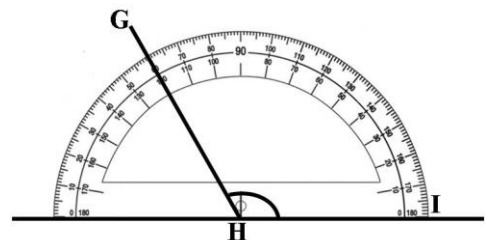

2. Draw an acute angle  $XOY$  with measure  $40^\circ$ .

**Solution:**

Follow the steps in example one above. Count  $40^\circ$  starting from the right.

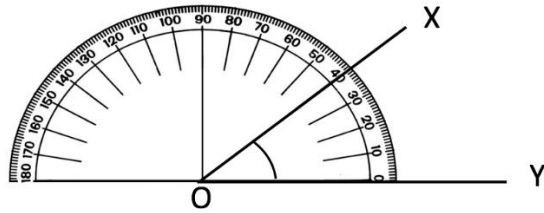

3. Draw an obtuse angle  $SOR$  with measure  $139^\circ$ .

**Solution:**

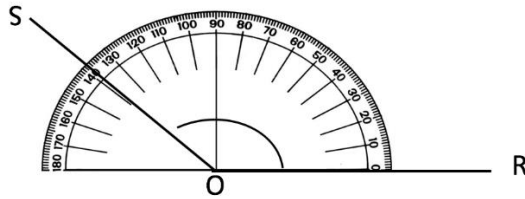

4. Draw angle  $XYZ$  with measure  $220^\circ$ .

**Solution:**

This is a reflex angle. Although it has more degrees than a protractor, we can still use a protractor to draw it. Start with a straight line, which we know is  $180^\circ$ . Use a protractor to extend the angle  $40^\circ$  more, to  $220^\circ$ :

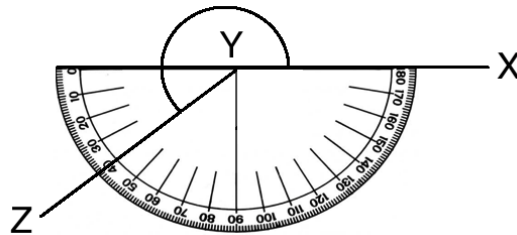

### Practice

Use your protractor to draw the following angles:

1.  $\angle ABC = 105^\circ$
2.  $\angle XYZ = 36^\circ$
3.  $\angle EFG = 248^\circ$
4.  $\angle RST = 148^\circ$

<b>Lesson Title:</b> Complementary and Supplementary angles	<b>Theme:</b> Geometry
<b>Practice Activity:</b> PHM1-L120	<b>Class:</b> SSS 1

	<p><b>Learning Outcomes</b> By the end of the lesson, you will be able to:</p> <ol style="list-style-type: none"> <li>1. Identify and describe complementary and supplementary angles.</li> <li>2. Classify angles as complementary or supplementary.</li> </ol>
---	--

**Overview**

Two angles are **complementary** when they add up to  $90^\circ$ . For example, in the diagram below,  $x$  and  $y$  are complementary angles:

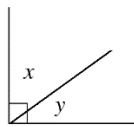

Complementary angles are not necessarily adjacent. For example, the following angles are complementary because their sum is  $90^\circ$ :



Two angles are **supplementary** when they add up to  $180^\circ$ . For example, in the diagram below,  $a$  and  $b$  are supplementary.

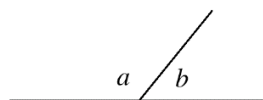

Supplementary angles are not necessarily adjacent. For example, the following angles are supplementary because their sum is  $180^\circ$ :



The easy way to remember complementary and supplementary angles are:

- 'C' of complementary stands for "corner" L (a Right Angle), and
- 'S' Supplementary stands for "straight" — (a Straight angle).

**Solved Examples**

1. Find the complement of each of the following angles:

- a.  $42^\circ$       b.  $60^\circ$       c.  $75^\circ$       d.  $25^\circ$

**Solutions:**



Remember that complementary angles are two angles that sum up to  $90^\circ$ .  
Therefore, subtract from  $90^\circ$  to find the complement of each angle:

a.  $90 - 42 = 48^\circ$

Therefore,  $48^\circ$  is the complement of  $42^\circ$ .

b.  $90 - 60 = 30^\circ$

$30^\circ$  is the complement of  $60^\circ$ .

c.  $90 - 75 = 15^\circ$

$15^\circ$  is the complement of  $75^\circ$ .

d.  $90 - 25 = 65^\circ$

$65^\circ$  is the complement of  $25^\circ$ .

2. Find the supplement of each of the following angles:

a.  $100^\circ$

b.  $90^\circ$

c.  $179^\circ$

d.  $120^\circ$

**Solutions:**

Remember that supplementary angles are two angles that sum up to  $180^\circ$ .

Therefore, subtract from  $180^\circ$  to find the supplement of each angle:

a.  $180 - 100 = 80^\circ$

$80^\circ$  is the supplement of  $100^\circ$ .

b.  $180 - 90 = 90^\circ$

$90^\circ$  is the supplement of  $90^\circ$ .

c.  $180 - 179 = 1^\circ$

$1^\circ$  is supplement of  $179^\circ$ .

d.  $180 - 120 = 60^\circ$

$60^\circ$  is the supplement of  $120^\circ$ .

3. Find the value of  $x$  in the diagrams below:

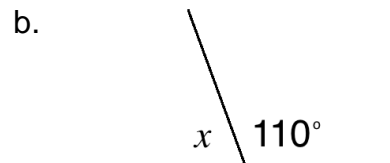
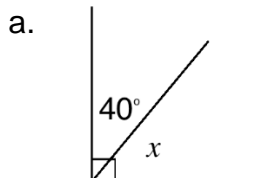

**Solutions:**

a.  $x + 40^\circ = 90^\circ$  complementary angles

$x = 90^\circ - 40^\circ$

$x = 50^\circ$

b.  $x + 110^\circ = 180^\circ$  supplementary angles

$x = 180^\circ - 110^\circ$

$x = 70^\circ$

4. a. If  $m$  and  $150^\circ$  are supplementary angles, find the value of  $m$ .

b. If  $p$  and  $35^\circ$  are complementary angles, find the value of  $p$ .

**Solutions:**

a.  $m + 150 = 180$

$$m = 180 - 150$$

$$m = 30^\circ$$

b.  $P + 35 = 90$

$$p = 90 - 35$$

$$P = 55^\circ$$

5. a. Find the complement of the angle that is  $\frac{2}{5}$  of  $90^\circ$ .  
b. Find the supplement of the angle that is  $\frac{2}{3}$  of  $180^\circ$ .

**Solutions:**

a. Find  $\frac{2}{5}$  of  $90^\circ$ :  $\frac{2}{5} \times 90 = 36^\circ$

Find the complement of  $36^\circ$ :  $90 - 36 = 54^\circ$

$54^\circ$  is the complement of  $\frac{2}{5}$  of  $90^\circ$ .

b. Find  $\frac{2}{3}$  of  $180^\circ$ :  $\frac{2}{3} \times 180 = 120^\circ$

Find the supplement of  $120^\circ$ :  $180 - 120 = 60^\circ$

$60^\circ$  is the supplement of  $\frac{2}{3}$  of  $180^\circ$ .

6. The measurement of two complementary angles are  $2x$  and  $(x + 15)$ . Find the value of  $x$ .

**Solution:**

Set the sum of the 2 angles equal to  $90^\circ$ , and solve for  $x$ :

$$2x + (x + 15) = 90^\circ$$

$$3x + 15 = 90^\circ$$

$$3x = 90^\circ - 15^\circ$$

$$3x = 75^\circ$$

$$x = \frac{75^\circ}{3} = 25^\circ$$

**Practice**

- Give the complement of the following angles:  
a.  $34^\circ$  b.  $37^\circ$  c.  $30^\circ$  d.  $70^\circ$
- What is the supplement of the following angles:  
a.  $110^\circ$  b.  $130^\circ$  c.  $75^\circ$  d.  $95^\circ$
- The measurement of two supplementary angles are  $(2x + 10)$  and  $(x + 20)$ . Find:  
a. The value of  $x$ ; b. The value of the smallest angle.
- Find the value of  $y$  in the diagrams below:

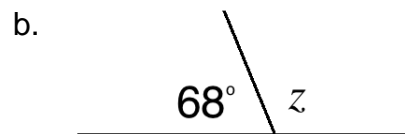
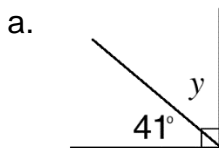

- The measurement of two complementary angles are  $y$  and  $(y + 20)$ . Find the value of  $y$ .
- Find the complement of the angle  $\frac{1}{3}$  of  $90^\circ$ .

<b>Lesson Title:</b> Parallel lines	<b>Theme:</b> Geometry
<b>Practice Activity:</b> PHM1-L121	<b>Class:</b> SSS 1



### Learning Outcomes

By the end of the lesson, you will be able to:

1. Describe parallel lines.
2. Use a compass to draw a set of parallel lines.

### Overview

Parallel lines are two lines that are always the same distance apart and never touch.

In order for two lines to be parallel, they must be drawn in the same plane, a perfectly flat surface like a wall or sheet of paper.

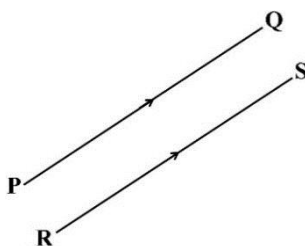

To show that lines are parallel, we draw small arrows marks on them.

The line segments above are parallel. In symbols, we write  $\overline{PQ} \parallel \overline{RS}$ . The symbol  $\parallel$  means “is parallel to”. Recall that the horizontal bar over the letters indicates it is a line segment.

Parallel lines can be constructed using a pair of compasses and a ruler. See solved example 2 for this construction.

### Solved Examples

1. The figure below shows a four sided plane shape ABCD with all sides equal. Identify the sets of parallel line segments in the figure

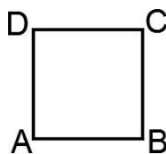

#### Solution:

For a shape with all sides equal, opposite sides are parallel. This figure could be a square or rhombus. In either case, we have  $\overline{AB} \parallel \overline{CD}$  and  $\overline{BC} \parallel \overline{DA}$ .

2. Construct parallel line segments  $\overline{PQ}$  and  $\overline{RS}$ .

#### Solution:

Follow the steps given in the table:

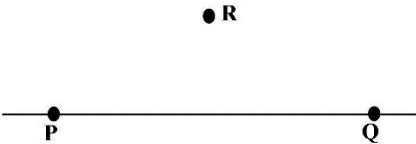
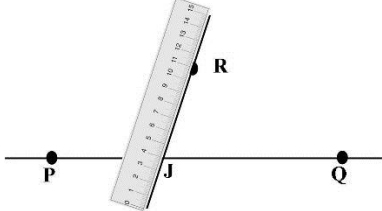
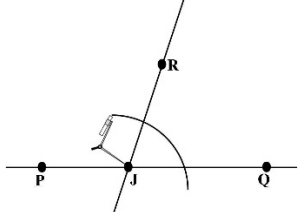
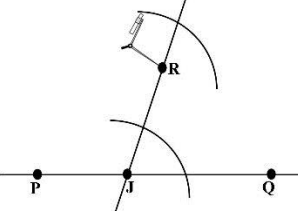
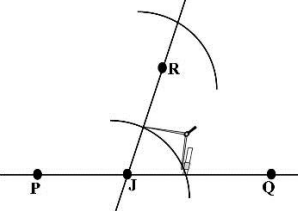
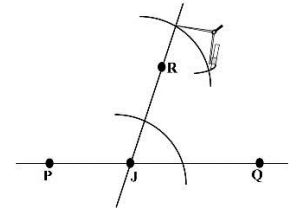
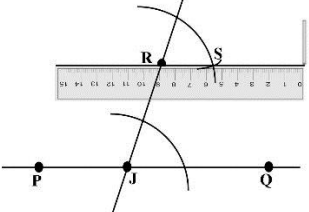
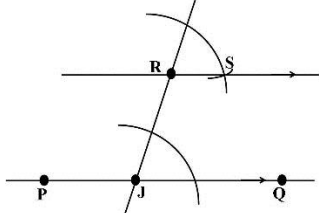
Steps	Diagrams
<p>Draw either of the line segments. We will start with <math>\overline{PQ}</math>. Draw a point <math>R</math> above the line.</p>	
<p>Draw a transversal line through <math>R</math> and across <math>PQ</math> at any point <math>J</math> where it intersects the line <math>PQ</math>.</p>	
<p>Use <math>J</math> as a centre and choose radius set to about half the distance <math>JR</math>. Draw an arc across both lines.</p>	
<p>Use the same radius, repeat at point <math>R</math>.</p>	
<p>Set the compass radius to the distance where the lower arc crosses the two lines</p>	
<p>Move the compasses to where the upper arc crosses the transversal line and draw an arc to make point <math>S</math>.</p>	
<p>Draw a straight line through <math>R</math> and <math>S</math> using a ruler.</p>	
<p>The construction is complete. The line <math>\overline{PQ}</math> is parallel to <math>\overline{RS}</math>. This can be written as <math>PQ \parallel RS</math>.</p>	

3. Construct a line parallel to line  $XY$  in the figure below.

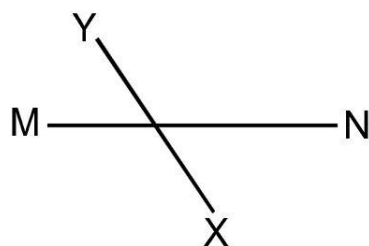

**Solution:**

**Step 1.** Redraw lines  $\overline{MN}$  and  $\overline{XY}$  as in figure, or draw directly on the figure above.

**Step 2.** Label point of intersection of  $\overline{MN}$  and  $\overline{XY}$  as  $O$ . Put compass point at  $o$ , open to a suitable radius and cut an arc to meet  $\overline{MN}$  and  $\overline{XY}$  at  $P$  and  $Q$ , respectively

**Step 3.** With the same radius, put the compass point at any point say  $O'$  along  $\overline{MN}$  and draw an arc to meet  $\overline{MN}$  at  $P'$

**Step 4.** Put the compass point at  $P$ , open to  $Q$  and draw an arc to meet arc  $PQ$  at  $Q$ .

**Step 5.** With the same radius as in step 4, transfer compass point to  $P'$  and cut an arc to meet the first arc at  $Q$ . The constructed line is parallel to  $\overline{XY}$ .

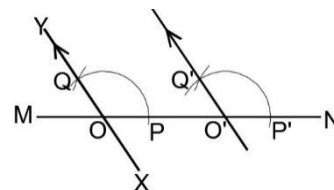

**Practice**

1. The figure below shows a rectangular octagon ABCDEFGH. By joining pairs of vertices of the octagon, identify all the pairs of parallel lines you can derive from the figure

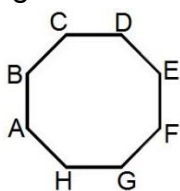

2. Use a pair of compasses to construct parallel line segments  $\overline{AB}$  and  $\overline{CD}$ .  
 3. Copy intersecting lines  $\overline{MN}$  and  $\overline{XY}$  on a piece of paper. Construct a line parallel to  $\overline{MN}$ .

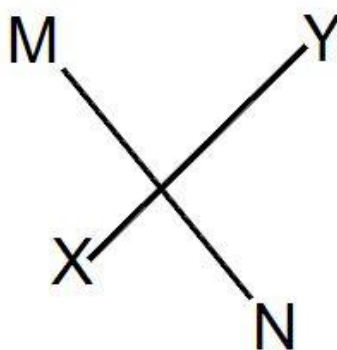

<b>Lesson Title:</b> Perpendicular lines	<b>Theme:</b> Geometry
<b>Practice Activity:</b> PHM1-L122	<b>Class:</b> SSS 1



### Learning Outcomes

By the end of the lesson, you will be able to:

1. Describe perpendicular lines.
2. Use a compass to draw a set of perpendicular lines and label the angle measurements.

### Overview

“Perpendicular” means that two lines meet at a right angle,  $90^\circ$ . A line is said to be perpendicular to another line if the two lines intersect at a right angle. In the diagram below,  $\overline{MN}$  is perpendicular to  $\overline{AB}$ . In symbols, this is written  $\overline{AB} \perp \overline{MN}$ .

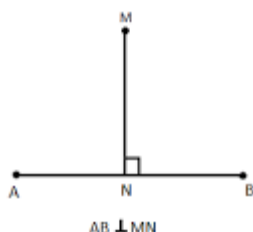

Perpendicular lines are often shown with a small square on the right angle. You can measure the angle with a protractor to check if the measure is  $90^\circ$ .

A perpendicular bisector divides a line into 2 equal segments. The steps for constructing a perpendicular bisector are given in the solved examples below.

### Solved Examples

1. Draw line segment  $\overline{AB}$ . Construct its perpendicular bisector  $\overline{PS}$ .

#### Solution:

Note that a perpendicular bisector divides a line segment into 2 equal parts. Thus, point  $P$  will be in the middle of line segment  $\overline{AB}$ .

**Step 1.** Draw a line of any length, mark a point  $P$  on it.

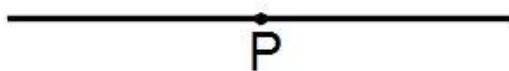

**Step 2.** With compass point at  $P$ , draw an arc that intercept the horizontal line at 2 points equidistant from  $P$ . Label these points  $A$  and  $B$ .

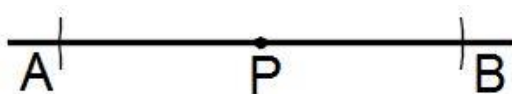

**Step 3.** Put the compass point at  $A$  and open the compass to a radius greater than  $\overline{AP}$ . Draw an arc above  $P$ .

**Step 4.** With the same radius, put the compass point at B and draw an arc above P. These two arcs will intersect at point S.

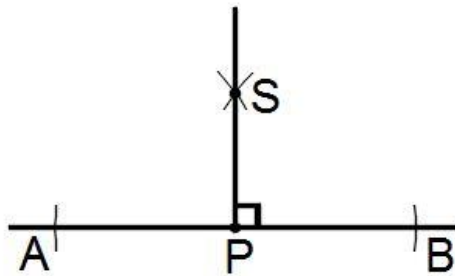

**Step 5.** Draw a line through S to P (line  $\overline{PS}$ ) which is perpendicular to line  $\overline{AB}$ .

2. Draw a line segment  $\overline{MN}$ . Draw a perpendicular  $\overline{PS}$  that intersects  $\overline{MN}$  at point O.

**Solution:**

Note that in this problem,  $\overline{PS}$  is not a perpendicular bisector. It is just a line that intersects  $\overline{MN}$  at any point, and does not necessarily divide  $\overline{MN}$  into equal parts.

**Step 1.** Draw an horizontal line and mark points M and N. Also mark point O at any point on line  $\overline{MN}$ , as shown:



**Step 2.** With compass point at O, draw arcs that intersect with MO and NO (equidistant from O).

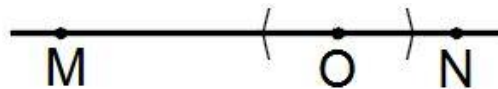

**Step 3.** Put compass point on one arc and open it beyond O. Draw an arc above O and below O.

**Step 4.** With the same radius, put compass point on the arc and draw arcs above O and below O. Mark the intersection of these arcs as P and S.

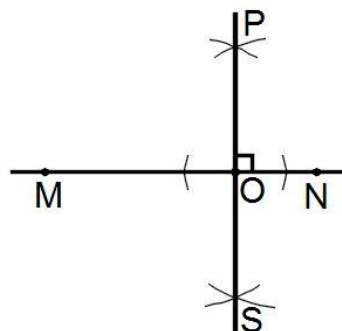

**Step 5.** Draw line  $\overline{PS}$  perpendicular to  $\overline{MN}$  at point O

### Practice

1. Draw line segment  $\overline{PE}$ . Construct a line  $\overline{FG}$  perpendicular to  $\overline{PE}$  at any point.
2. Draw a line segment  $\overline{AB}$ . Construct a line ST perpendicular to  $\overline{AB}$  at point N.
3. Draw a line segment  $\overline{PQ}$ . Construct its perpendicular bisector at point O.



<b>Lesson Title:</b> Alternate and corresponding angles	<b>Theme:</b> Geometry
<b>Practice Activity:</b> PHM1-L123	<b>Class:</b> SSS 1

	<p><b>Learning Outcomes</b> By the end of the lesson, you will be able to:</p> <ol style="list-style-type: none"> <li>1. Identify and describe alternate and corresponding angles.</li> <li>2. Classify angles as alternate and corresponding.</li> </ol>
---	---

### Overview

A **transversal line** is one that intersects two parallel lines. This lesson is on two types of angles formed when a transversal intersects parallel lines: **alternate** and **corresponding angles**. Examples are shown below:

a. Alternate angles

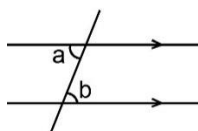

b. Corresponding angles

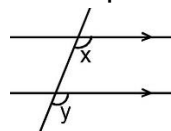

When a transversal line intersects parallel lines, there are two pairs of alternate angles and there are four pairs of corresponding angles. Alternate angles are equal, and corresponding angles are equal.

Alternate angles form a **Z** pattern:

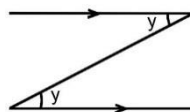

Corresponding angles form an **F** pattern:

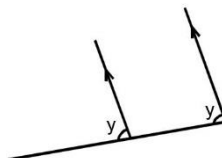

### Solved Examples

1. Find the value of the angles marked with small letters in the diagrams below. State your reasons.

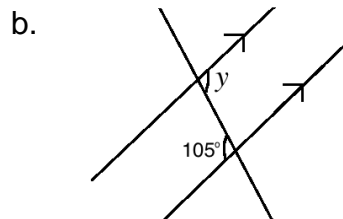
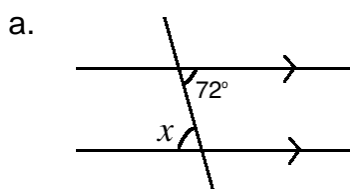

#### Solutions:

- a.  $x = 72^\circ$ , because they are alternate angles
- b.  $y = 105^\circ$ , because they are alternate angles

2. Find the value of  $m$  in the diagrams below. State your reasons.

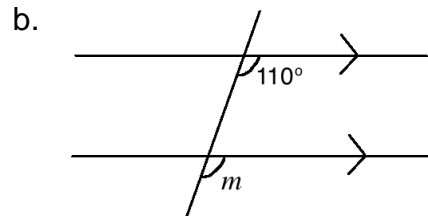
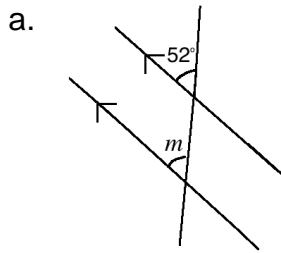

**Solutions:**

a.  $m = 52^\circ$ , because they are corresponding angles.

b.  $m = 110^\circ$ , because they are corresponding angles.

3. Find the value of the angles marked with small letters in the diagram below. State your reasons.

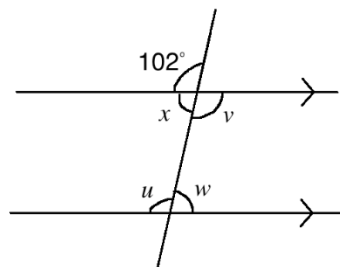

**Solution:**

$u = 102^\circ$ , because it is a corresponding angle to  $102^\circ$ .

$v = u = 102^\circ$ , because they are alternate angles.

$x$  and  $102^\circ$  are supplementary angles; use this to find  $x$ :

$$\begin{aligned} x + 102^\circ &= 180^\circ \\ x &= 180^\circ - 102^\circ \\ x &= 78^\circ \end{aligned}$$

$w = x = 78^\circ$ , because they are alternate angles.

4. Find the value of the angles marked with small letters in the diagram below. State your reasons.

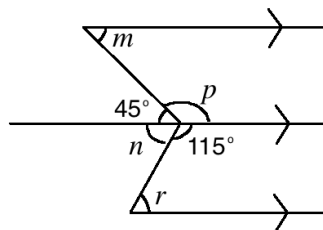

**Solution:**

$m = 45^\circ$ , because its alternate angle is  $45^\circ$ .

$p$  and  $45^\circ$  are supplementary angles; use this to find  $p$ :

$$\begin{aligned} p + 45^\circ &= 180^\circ \\ p &= 180^\circ - 45^\circ \\ p &= 135^\circ \end{aligned}$$

$n$  and  $115^\circ$  are supplementary angles; use this to find  $n$ :

$$\begin{aligned}
 n + 115^\circ &= 180^\circ \\
 n &= 180^\circ - 115^\circ \\
 n &= 65^\circ
 \end{aligned}$$

$r = n = 65^\circ$ , because these are alternate angles.

5. Find the measure of angle  $k$  in the diagram below.

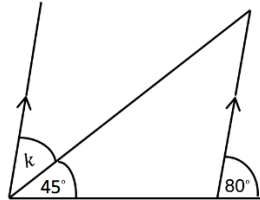

**Solution:**

The angle marked  $80^\circ$  corresponds to the full angle  $k + 45^\circ$ . Set these equal, and solve for  $k$ .

$$\begin{aligned}
 k + 45^\circ &= 80^\circ \\
 k &= 80^\circ - 45^\circ \\
 k &= 35^\circ
 \end{aligned}$$

**Practice**

1. Find the value of the angles marked with small letters in the diagrams below. State your reasons.

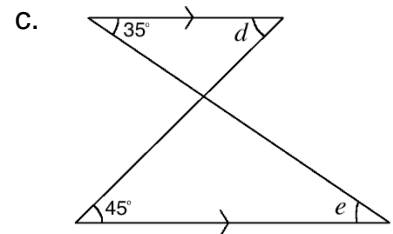
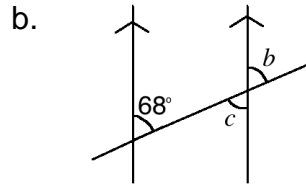
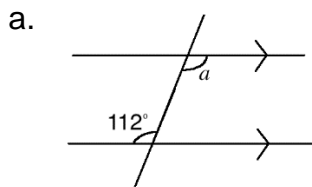

2. Find the value of the following marked with small letters in the diagrams below. State your reasons.

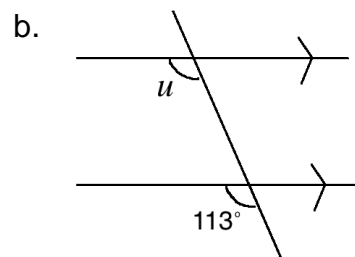
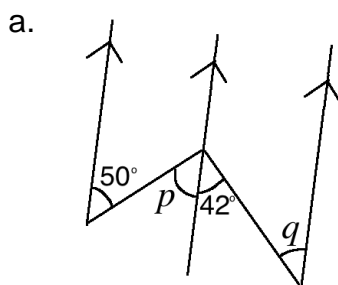

<b>Lesson Title:</b> Adjacent and Opposite angles	<b>Theme:</b> Geometry
<b>Practice Activity:</b> PHM1-L124	<b>Class:</b> SSS 1

	<p><b>Learning Outcomes</b> By the end of the lesson, you will be able to:</p> <ol style="list-style-type: none"> <li>1. Identify and describe adjacent and opposite angles.</li> <li>2. Classify angles as adjacent or opposite.</li> </ol>
---	--

**Overview**

This lesson is on 2 additional types of angles that are formed by intersecting lines, which are adjacent and opposite angles. In the examples below, the following are adjacent angles: a and b; c and d. The following are opposite angles: q and p; r and s.

a. Adjacent angles

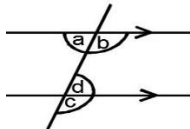

b. Opposite angles

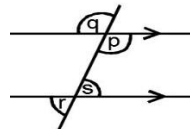

When a transversal intersects parallel lines, there are eight pairs of adjacent angles and four pairs of opposite angles. Adjacent angles sum up to  $180^\circ$  because they are supplementary. Opposite angles are equal.

An easy way to identify an adjacent angle is they are angles on a straight line, while opposite angles form a X pattern.

**Solved Examples**

1. Find the value of  $x$  in the diagram below:

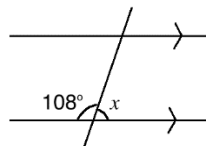

**Solution:**

$x$  and  $108^\circ$  are supplementary angles because they are adjacent; therefore:

$$\begin{aligned}
 x + 108^\circ &= 180^\circ \\
 x &= 180^\circ - 108^\circ \\
 x &= 72^\circ
 \end{aligned}$$

2. Find the value of the angles marked with small letter in the diagram below. State your reasons.

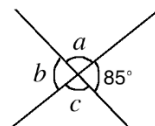

**Solution:**

$a$  and  $85^\circ$  are supplementary angles because they are adjacent:

$$\begin{aligned} a + 85^\circ &= 180^\circ \\ a &= 180^\circ - 85^\circ \\ a &= 95^\circ \end{aligned}$$

$b = 85^\circ$  because these are opposite angles

$c = a = 95^\circ$  because these are opposite angles

3. Find the angles marked with small letters in the diagrams below. State reasons.

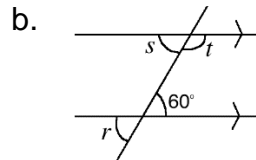
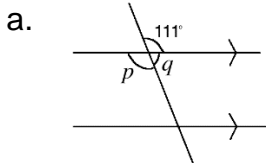

**Solutions:**

a.  $p = 111^\circ$  (Opposite angles)

$q$  and  $111^\circ$  are supplementary angles because they are adjacent:

$$\begin{aligned} q + 111^\circ &= 180^\circ \\ q &= 180^\circ - 111^\circ \\ q &= 69^\circ \end{aligned}$$

b.  $r = 60^\circ$  (Opposite angles)

$s = 60^\circ$  (Alternate angles)

$s$  and  $t$  are supplementary angles because they are adjacent:

$$\begin{aligned} s + t &= 60^\circ + t = 180^\circ \\ t &= 180^\circ - 60^\circ \\ q &= 120^\circ \end{aligned}$$

4. Find the value of the angles marked with small letters in the diagrams below. State your reasons.

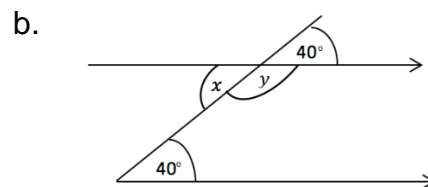
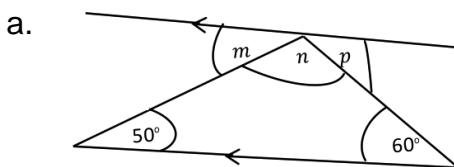

**Solutions:**

a.  $m = 50^\circ$  because they are alternate angles

$p = 60^\circ$  because they are alternate angles

Note that  $m$ ,  $n$  and  $p$  form a straight line, and thus sum to  $180^\circ$ :

$$\begin{aligned} m + n + p &= 180^\circ \\ 50^\circ + n + 60^\circ &= 180^\circ \\ n &= 180^\circ - 110^\circ \\ n &= 70^\circ \end{aligned}$$

b.  $x = 40^\circ$  because they are alternate angles

Note that  $y$  and  $40^\circ$  are supplementary angles:

$$40^\circ + y = 180^\circ$$

$$y = 180^\circ - 40^\circ$$

$$y = 140^\circ$$

5. Find the value of the lettered angles in the diagram.  
Give your reasons.

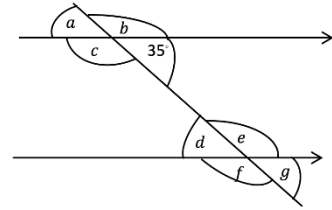

**Solution :**

$a = 35^\circ$  Opposite angles

$c$  and  $35^\circ$  are supplementary:

$$35^\circ + c = 180^\circ$$

$$c = 180^\circ - 35^\circ$$

$$c = 145^\circ$$

$b = c = 145^\circ$  Opposite angles

$d = 35^\circ$  Alternate angles

$e = b = 145^\circ$  Corresponding angles

$f = e = 145^\circ$  Opposite angles

$g = d = 35^\circ$  opposite angles

**Practice**

1. Find the values of the angles marked with small letters in the diagrams below.  
State your reasons.

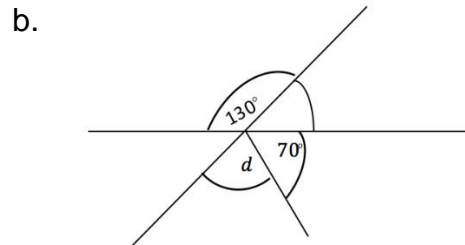
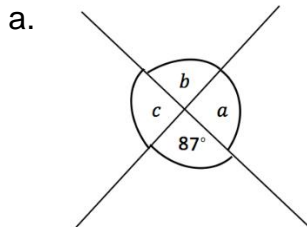

2. Find the value of the lettered angles in the diagrams below.

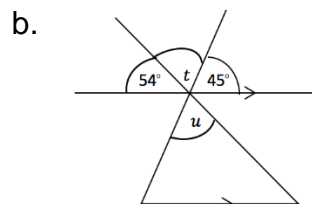
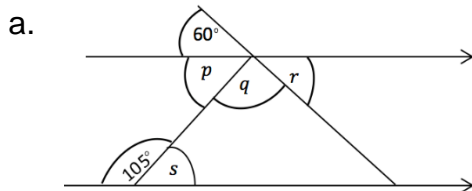

3. Find the value of the angles marked with small letters. State your reasons.

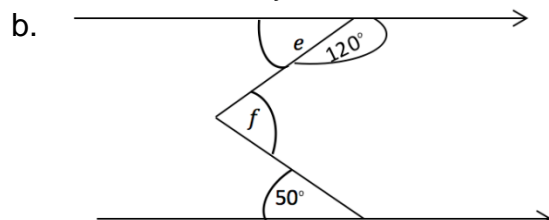
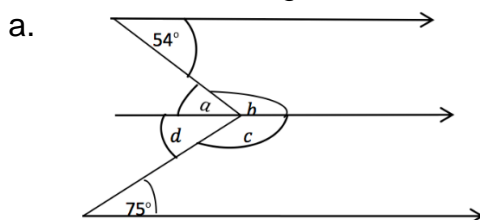

<b>Lesson Title:</b> Interior and exterior angles	<b>Theme:</b> Geometry
<b>Practice Activity:</b> PHM1-L125	<b>Class:</b> SSS 1

	<p><b>Learning Outcomes</b></p> <p>By the end of the lesson, you will be able to:</p> <ol style="list-style-type: none"> <li>1. Identify and describe interior and exterior angles.</li> <li>2. Classify as interior or exterior.</li> </ol>
---	--

**Overview**

This lesson is on identifying the interior and exterior angles of shapes.

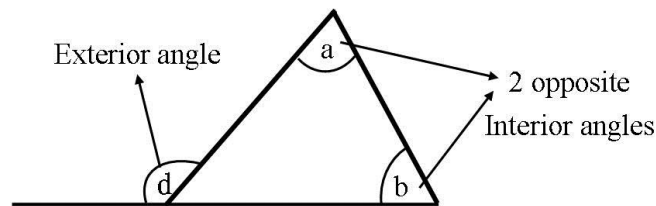

In the diagram,  $a$  and  $b$  are called interior angles. An interior angle is an angle inside a shape. The angle  $d$  is an exterior angle. Exterior angle of a shape is formed by any side of the shape and the extension of its adjacent sides.

All types of polygons have interior and exterior angles.

**Solved Examples**

1. From the diagram below, identify the:
  - a. Interior angles
  - b. Exterior angles

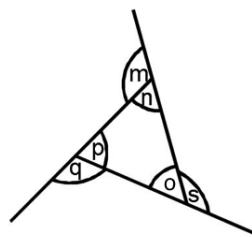

**Solutions:**

- a. Interior angles are:  $\angle n, \angle p, \angle o$
- b. Exterior angles are:  $\angle m, \angle q, \angle s$

2. Identify the interior angle and exterior angles labeled in the diagrams below:

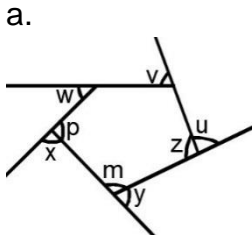

**Solutions:**

- a. Interior angles:  $\angle p, \angle m, \angle z$   
 Exterior angles:  $\angle u, \angle v, \angle w, \angle x, \angle y$   
 b. Interior angles:  $56^\circ, 60^\circ, 64^\circ$   
 Exterior angles:  $116^\circ, 120^\circ$

3. Classify each angle in the diagrams below as an interior or exterior angle.

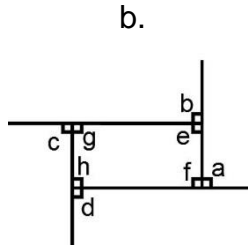
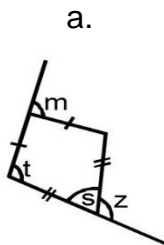

**Solutions:**

- a. Interior angles:  $\angle s, \angle t$   
 Exterior angles:  $\angle m, \angle z$   
 b. Interior angles:  $\angle e, \angle f, \angle g, \angle h$   
 Exterior angles:  $\angle a, \angle b, \angle c, \angle d$

**Practice**

1. Identify the interior and exterior angles from the diagrams below.

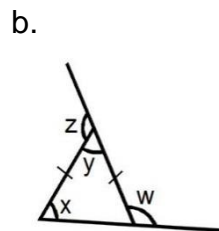
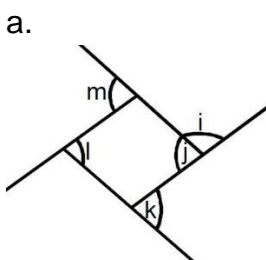

2. Identify the Interior angles and exterior angles from the diagrams below.

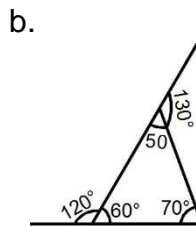
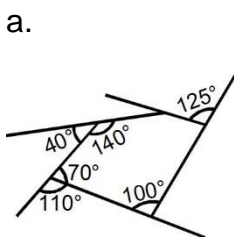



3. Classify each angle in the diagrams below as an interior or exterior angle.

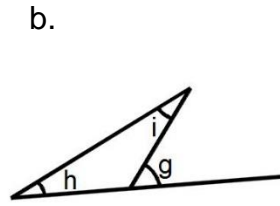
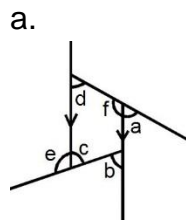

<b>Lesson Title:</b> Practical application of angle measurement	<b>Theme:</b> Geometry
<b>Practice Activity:</b> PHM1-L126	<b>Class:</b> SSS 1

 <b>Learning Outcome</b> By the end of the lesson, you will be able to measure angles in real life.
---

## Overview

Angles are very useful in everyday life. Some of the professions that use angle measurements in their jobs are carpenters, builders, engineers, and tailors.

We shall be measuring items or objects that are frequently used in our surroundings.

## Solved Examples

- The figure below shows a boy looking straight ahead of him at a flagpole. He then decides to look at the top of the flagpole. Measure the following angles with a protractor:
  - Between his initial line of gaze and the flagpole ( $\angle a$ ).
  - Between the boy's initial line of gaze and the final line of gaze at the top of the flagpole ( $\angle r$ ).
  - Between the boy's final line of gaze and the flagpole ( $\angle b$ ).

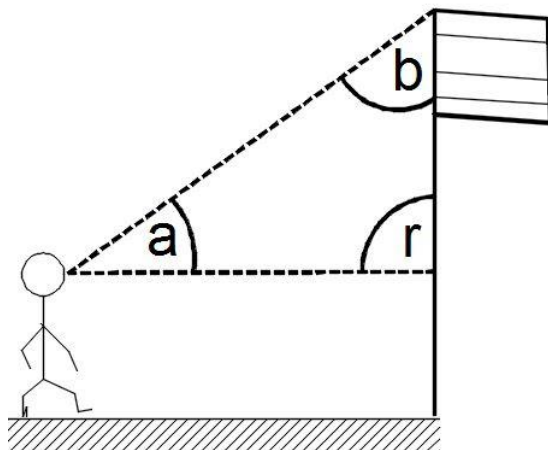

### Solutions:

Using a protractor to measure each angle in the diagram above, you should find:

- $\angle a = 35^\circ$
  - $\angle r = 90^\circ$ , a right angle
  - $\angle b = 55^\circ$
- The figure below shows the plan view of a revolving door at the entrance of a public building. The revolving door has a leaf that revolves around the centre to allow people into the building. The dotted line shows the initial position of the leaf of the door when it is locked. Four people entered the building in succession (one

after the other). A, B, C and D represent the position of the leaf of the door after the four people entered. Measure the angles turned through by the leaf of the door from its initial position after each person entered.

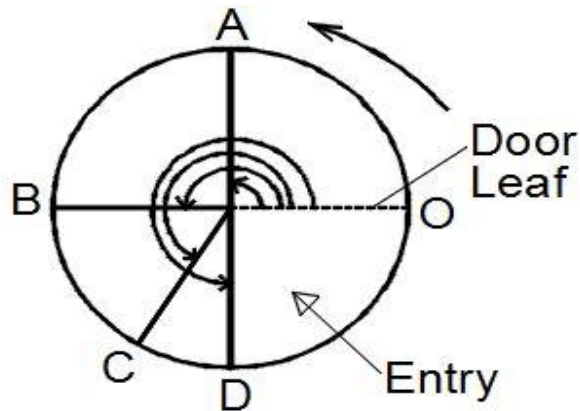

**Solution:**

Let  $X$  be the centre of the revolving door. We will use this to measure angles of rotation. With respect to the initial position of the door leaf:

- Using a protractor to measure the angle turned through by the door leaf after A, you should get  $90^\circ$   $\angle OXA = 90^\circ$
- Using a protractor to measure the angle turned through by the door leaf after B, you should get  $\angle OXB = 180^\circ$  (straight angle)
- Using a protractor to measure the angle turned through by the door leaf after C, you should get  $\angle OXC = 235^\circ$ , which is greater than  $180^\circ$  but lesser than  $270^\circ$  (a reflex angle).
- Using a protractor to measure the angle turned through by the door leaf after D, you should get  $\angle OXD = 270^\circ$

3. In order to get different radii on a compass a pupil turned the pencil point of a pair of compasses through the following angles indicated by  $a^\circ, b^\circ, c^\circ$  as shown below. Measure a, b, and c with a protractor.

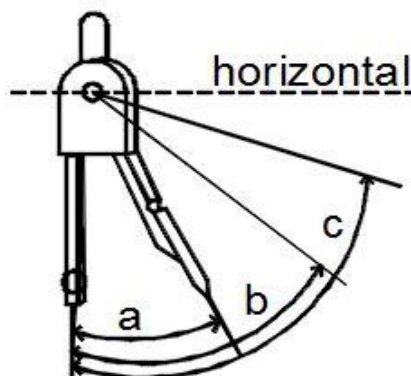

**Solution:**

Observe that angles  $a$ ,  $b$ , and  $c$  should all be acute angles, less than  $90^\circ$ .  
Measuring them, they are approximately:  $\angle a = 35^\circ$ ,  $\angle b = 55^\circ$ ,  $\angle c = 75^\circ$ .

**Practice**

1. A boy on the second floor of his house looked straight ahead of him. He then turned his gaze downwards to look at two objects A and B on the ground as shown in the figure below. Measure the angles  $x$ ,  $y$ , and  $z$  in the diagram:

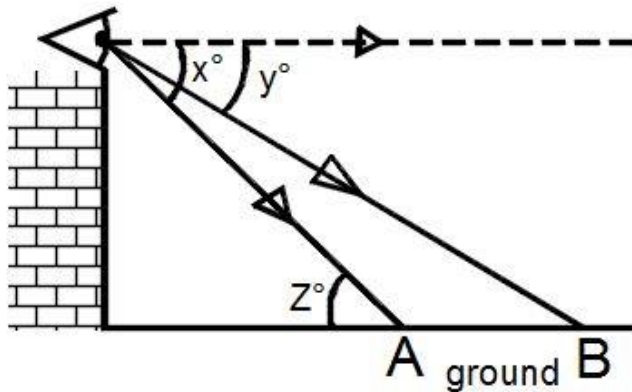

2. The figures below shows analogue clocks with the minute hand constant pointing at 12. Measure the angle between the minute hand and the hour hand in each diagram:

a.

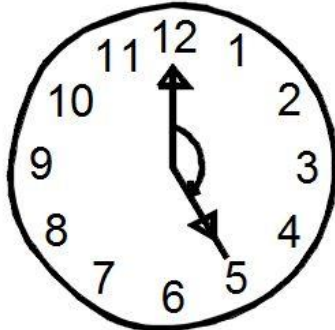

b.

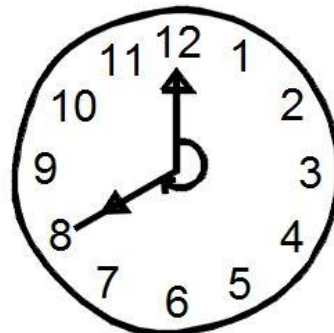

3. In a surveying exercise, 3 angles were measured for different elevations as shown below. Use a protractor to measure each angle.

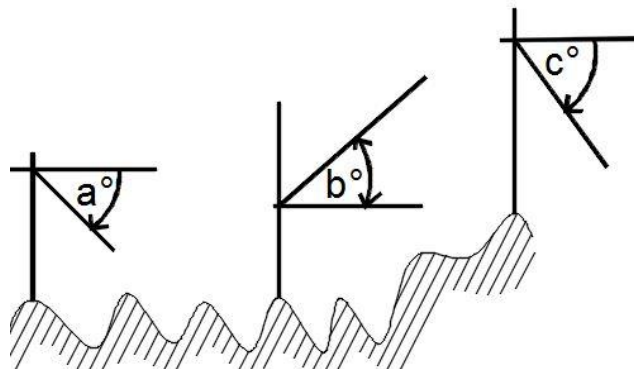

<b>Lesson Title:</b> Word problems involving angle measurement	<b>Theme:</b> Geometry
<b>Practice Activity:</b> PHM1-L127	<b>Class:</b> SSS 1



### Learning Outcome

By the end of the lesson, you will be able to solve word problems involving the measurements of angles.

## Overview

There are many word problems which involve the measurement of angles. These can be written in the form of equations to be solved.

Remember these basic steps that can be used to solve many word problems:

- Assign a variable to represent each unknown angle.
- Write the algebraic expression representing the situation.
- Solve the equation for the unknown angles.

## Solved Examples

1. A pizza is to be shared equally among some children in a class. If the angle subtended by each slice is  $20^\circ$ ; determine the number of children among whom the pizza was shared.

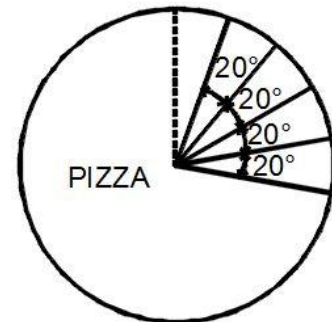

### Solution:

Let number of children receiving equal share of pizza be  $x$  children

Total angle subtended by slices shared among  $x$  children =  $20^\circ x$

Recall that there are  $360^\circ$  in a full rotation, so the pizza has  $360^\circ$  in total.

This gives the equation  $20^\circ x = 360^\circ$ , which we can solve for  $x$ :

$$20^\circ x = 360^\circ$$

$$x = \frac{360^\circ}{20^\circ}$$

$$x = 18 \text{ children}$$

2. In an isosceles triangle, each of the equal angles is twice the third angle.
  - a. Sketch the triangle
  - b. Find the angles of the triangle

### Solutions:

- a. Draw a sketch of the triangle. Make sure the equal angles are larger than the third angle, and label the angles.

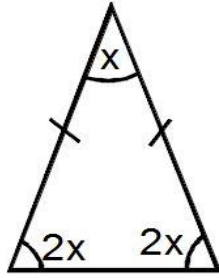

b. Let the vertical angle of the triangle be  $x$ . Each base angle of triangle =  $2x$

Then the sum of the angles in the triangle is  $x + 2x + 2x = 5x$

We also know that the sum of the angles in a triangle is  $180^\circ$ . This gives the equation  $5x = 180^\circ$ . Solve the equation for  $x$ :

$$5x = 180^\circ$$

$$x = \frac{180^\circ}{5} = 36^\circ$$

Substitute  $x$  to find the measure of each angle:

The 2 equal angles are  $2x = 2(36^\circ) = 72^\circ$  and the third angle is  $x = 36^\circ$ .

3. One of the angles of a triangle is  $15^\circ$  more than the second angle, and  $10^\circ$  more than the third angle. Find the angles of the triangle.

**Solution:**

Let one of the angles of the triangle be  $x$ , the other angles will be  $x + 15^\circ$  and  $x + 10^\circ$ . Draw a diagram:

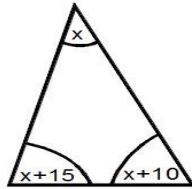

Set the sum of the angles of the triangle equal to  $180^\circ$  and solve for  $x$ :

$$x + x + 15^\circ + x + 10^\circ = 180^\circ$$

$$3x + 25^\circ = 180^\circ$$

$$3x = 180^\circ - 25^\circ$$

$$3x = 155^\circ$$

$$x = \frac{155^\circ}{3} = 51.7^\circ$$

The first angle is  $x = 51.7^\circ$ . Use this to find the measures of the other 2 angles:

$$x + 15 = 66.7^\circ$$

$$x + 10 = 61.7^\circ$$

### Practice

1. A circular birthday cake is sliced equally into sectors among 20 children at a birthday party. What will be the angle subtended at the centre of each piece of cake?

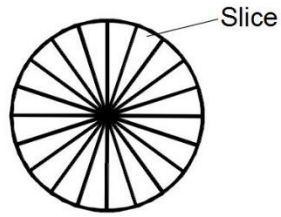

2. In a right angle triangle, one of the acute angles is  $20^\circ$  lesser than the other. Find the angles of the triangle.
3. The figure below shows a ladder leaning against a vertical wall and the other end resting against a horizontal ground. If the angle between the ground measured clockwise from the ground to the ladder is  $120^\circ$ , determine the angles of the triangle formed by the ladder the vertical wall and the horizontal ground.

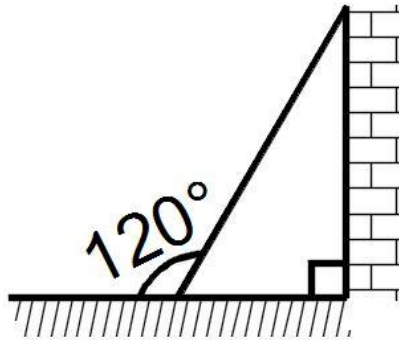

<b>Lesson Title:</b> Bisectors of angles and lines	<b>Theme:</b> Geometry
<b>Practice Activity:</b> PHM1-L128	<b>Class:</b> SSS 1

	<p><b>Learning Outcome</b> By the end of the lesson, you will be able to identify bisectors of angles and line segments.</p>
---	--

**Overview**

An angle bisector is a line or ray that divides an angle into two equal angles. To bisect angle *A* simply means to divide angle *A* into two equal angles.

A line bisector is the line that passes through the midpoint of a given segment. A midpoint is point on a line segment that divides it into two equal segments. A line, segment, or ray that passes through a midpoint of another segment is called a segment bisector.

A segment bisector is called a perpendicular bisector when the bisector intersects the segment at right angles.

**Solved Examples**

1. Given the figure below,
  - a. List down the values of the angles  $\angle A$ ,  $\angle B$  and  $\angle C$
  - b. Identify the size of the angles that will be formed by bisecting each angle of the triangle.
  - c. Use a protractor to bisect each angle of the triangle.

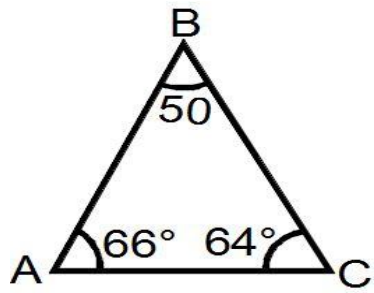

**Solution:**

- a.  $\angle A = 66^\circ$ ,  $\angle B = 50^\circ$ ,  $\angle C = 64^\circ$
- b. Bisecting angle *A* will give angles of:  $\frac{66^\circ}{2} = 33^\circ$   
 Bisecting angle *B* will give angles of:  $\frac{50^\circ}{2} = 25^\circ$   
 Bisecting angle *C* will give angles of:  $\frac{64^\circ}{2} = 32^\circ$
- c. Use a protractor to bisect each angle as shown:

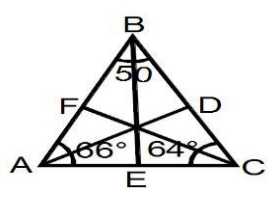



2. Use your protractor to draw an angle of  $130^\circ$ . Then, use the protractor to draw the bisector of the angle.

**Solution:**

Use the protractor to draw the angle, as shown below. Then, find the measures of each angle formed by the bisector:  $\frac{130^\circ}{2} = 65^\circ$ .

Draw the angle bisector with  $65^\circ$  on either side:

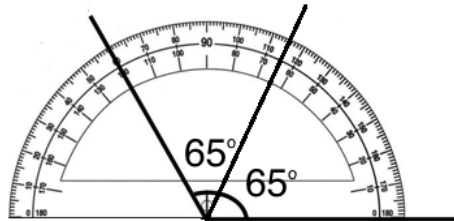

3. Draw a line segment  $|AB| = 5$  cm. On this segment:
- Locate the centre point and label it C.
  - Draw a perpendicular line XY through C.

**Solution:**

Note that the line below is not drawn to scale. Make sure your own segment is 5 cm in length.

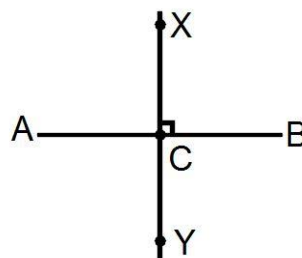

4. Draw a line segment  $|PQ| = 60$  mm. On this segment:
- Locate the centre point and label it R.
  - Draw a non-perpendicular line UV through R.

**Solution:**

Note that the line below is not drawn to scale. Make sure your own segment is 60 mm in length, which is equal to 6 cm.

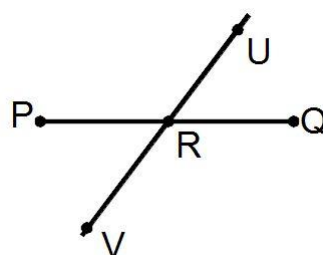

## Practice

1. Given the figure below:

- List the measures of the angles  $\angle L$ ,  $\angle M$  and  $\angle N$ .
- Using a protractor, draw the angle bisectors of  $\angle L$ ,  $\angle M$  and  $\angle N$

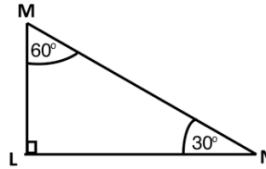

2. Given an Isosceles triangle ABC as shown below:

- Draw the bisector of  $\angle B$
- Mark where the angle bisector of  $\angle B$  meets the opposite side as D.
- Measure angles  $\angle ABD$  and  $\angle CBD$ , and record their measures.

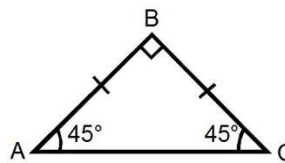

- Draw a line segment  $|MN| = 56$  mm. Draw its perpendicular bisector XY.
- Draw a line segment  $|ST| = 6.6$  cm. Draw a bisector XY that is not perpendicular to the line.

<b>Lesson Title:</b> Intercept theorem	<b>Theme:</b> Geometry
<b>Practice Activity:</b> PHM1-L129	<b>Class:</b> SSS 1



### Learning Outcome

By the end of the lesson, you will be able to use the intercept theorem to calculate line segments.

### Overview

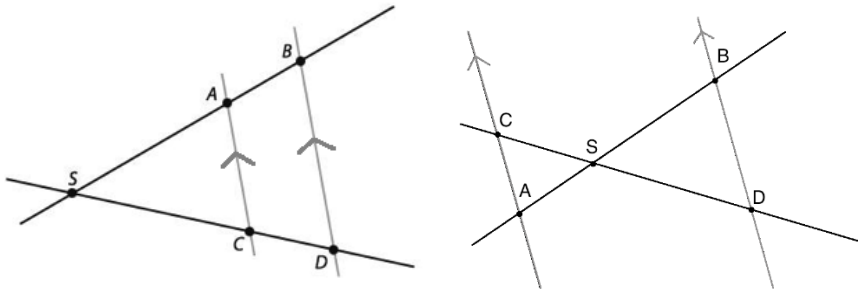

The intercept theorem is about the ratio of line segments. We have two lines intersecting at point  $S$ . The same theorem applies to these 2 diagrams. In the first diagram, the lines intersect outside of the 2 parallel lines, and in the second diagram they intersect between the 2 parallel lines.

The lines intersect the parallel lines in points  $A, B, C$  and  $D$ . The points make up various line segments such as  $\overline{SA}$  (the line from  $S$  to  $A$ );  $\overline{AC}$  (the line from  $A$  to  $C$ ) and so on. The theorem tells us about the ratios of the lengths of these line segments.

From the diagrams above, we have the following ratios of the line segments:

$$\begin{array}{ccc} \frac{SA}{SB} = \frac{SC}{SD} & \frac{SA}{AB} = \frac{SC}{CD} & \frac{SA}{AC} = \frac{SB}{BD} \\ \frac{SC}{AC} = \frac{SD}{BD} & \frac{SA}{SB} = \frac{AC}{BD} & \frac{SC}{SD} = \frac{AC}{BD} \end{array}$$

Carefully observe each ratio in the diagrams above. These ratios can be used to find the lengths of line segments.

### Solved Examples

1. Calculate the length  $OC$  in the figure below:

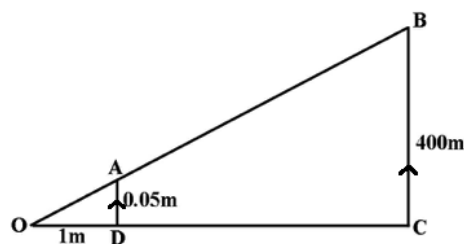

**Solution:**

If the straight line  $AD$  and  $BC$  are parallel, then the ratios  $\frac{OB}{OA}, \frac{OC}{OD}$  and  $\frac{BC}{AD}$  are equal.

It is an intercept theorem.

Take  $\frac{OC}{OD} = \frac{BC}{AD}$ :

$$\begin{aligned} \frac{OC}{1} &= \frac{400}{0.05} && \text{Substitute known sides} \\ OC &= \frac{1 \times 400}{0.05} && \text{Cross multiply} \\ OC &= \frac{400}{0.05} && \text{Solve for } OC \\ OC &= 8000 \text{ m} \end{aligned}$$

2. Find the length of  $y$  in the diagram below. Give your answer to 1 decimal place.

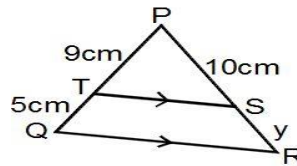

**Solution:**

From the intercept theorem, we have  $\frac{PT}{TQ} = \frac{PS}{SR}$ .

Substitute the given values, and solve for  $y$ :

$$\begin{aligned} \frac{9}{5} &= \frac{10}{y} && \text{Substitute known sides} \\ 9y &= 5 \times 10 && \text{Cross multiply} \\ y &= \frac{5 \times 10}{9} && \text{Solve for } y \\ y &= \frac{50}{9} \\ y &= 5.6 \text{ cm} \end{aligned}$$

3. Find the missing sides marked with small letters in the diagram below

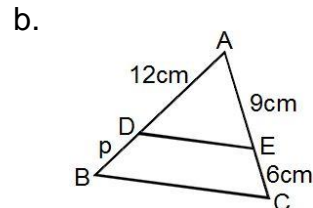
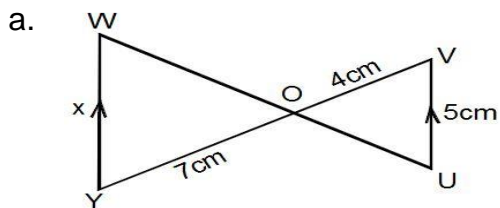

**Solutions:**

a.

$$\begin{aligned} \frac{WY}{YO} &= \frac{VO}{OU} \\ \frac{x}{7} &= \frac{4}{5} \\ 4x &= 5 \times 7 \\ x &= \frac{5 \times 7}{4} \\ x &= 8.75 \text{ cm} \\ x &= 9 \text{ cm} \end{aligned}$$

b.

$$\begin{aligned} \frac{AD}{DB} &= \frac{AE}{EC} \\ \frac{12}{p} &= \frac{9}{6} \\ 9p &= 12 \times 6 \\ p &= \frac{12 \times 6}{9} \\ p &= 8 \text{ cm} \end{aligned}$$

**Practice**

1. Find the lengths of the missing sides marked with lowercase letters each diagram below. Give your answers to 1 decimal place.

a.

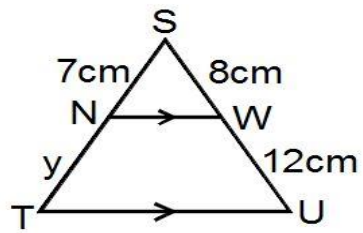

b.

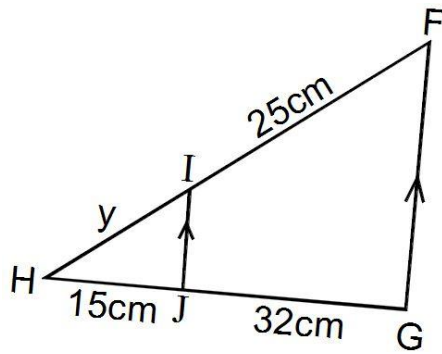
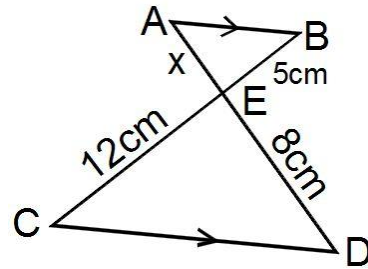

<b>Lesson Title:</b> Angle problem solving	<b>Theme:</b> Geometry
<b>Practice Activity:</b> PHM1-L130	<b>Class:</b> SSS 1



### Learning Outcome

By the end of the lesson, you will be able to apply angle theorems and properties to solve problems, including word problems.

## Overview

This lesson uses information from previous lessons to solve problems related to angles. You may look at the previous lessons for support in solving these problems.

## Solved Examples

1. In the diagram below, find the measures of: a.  $\angle COB$       b.  $\angle BOD$       c.  $\angle AOD$

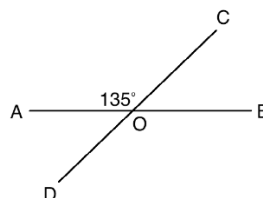

### Solutions:

- Note that  $\angle AOC$  and  $\angle COB$  form a straight line, and thus are supplementary angles. Subtract from  $180^\circ$  to find  $\angle COB$ :  $\angle COB = 180^\circ - 135^\circ = 45^\circ$
- Note that  $\angle AOC$  and  $\angle BOD$  are opposite angles, and are thus equal.  $\angle BOD = \angle AOC = 135^\circ$
- Angle  $\angle AOD$  can be found in multiple ways. Use the opposite angle  $\angle COB$ , or the supplementary angles  $\angle AOC$  or  $\angle BOD$ . We have  $\angle AOD = \angle COB = 45^\circ$ .

2. In the diagram below,  $AB \parallel CD$  and  $EB \parallel CF$ . Find the measure of  $\angle BCD$ .

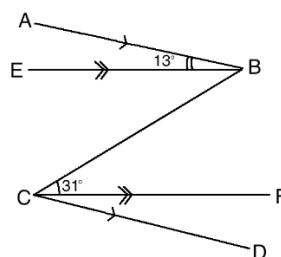

### Solution:

Note that  $BC$  is a transversal for both sets of parallel lines. Thus, we can label the alternate angles as equal. We have  $\angle ABC = \angle BCD$  and  $\angle EBC = \angle BCF$ . This is shown in the diagram:

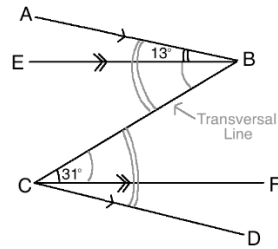

Since we are given  $\angle BCF = 31^\circ$ , we also have  $\angle EBC = 31^\circ$ . Add  $\angle ABE$  and  $\angle EBC$  to find  $\angle ABC$ :  $\angle ABC = \angle ABE + \angle EBC = 13^\circ + 31^\circ = 44^\circ$ .

Therefore,  $\angle BCD = \angle ABC = 44^\circ$ .

3. Find the measures of  $a$ ,  $b$ , and  $c$  in the diagram:

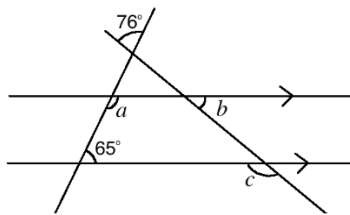

**Solution:**

Note that  $a$  and  $65^\circ$  are co-interior angles, and are thus supplementary.  $a = 180^\circ - 65^\circ = 115^\circ$ .

Find the interior angles of the triangle. These angles can be used to find  $b$ . The angle adjacent to  $a$  corresponds to  $65^\circ$ , and the top interior angle of the triangle is  $76^\circ$  because that is the measure of the opposite angle. Therefore, the angle opposite  $b$  is:  $180^\circ - 65^\circ - 76^\circ = 39^\circ$ .

We also have  $b = 39^\circ$  because they are opposite angles.

$c$  corresponds to an angle that is supplementary to  $b$ , so we have  $c = 180^\circ - b = 180^\circ - 39^\circ = 141^\circ$ .

**Answer:**  $a = 115^\circ$ ,  $b = 39^\circ$ ,  $c = 141^\circ$ .

## Practice

1. In the diagram below, find the measures of  $a$ ,  $b$ ,  $c$  and  $d$ :

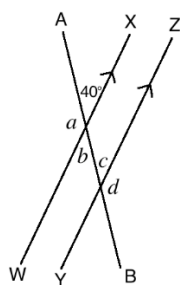

2. Find the measures of  $a$ ,  $b$ , and  $c$  in the diagram below:

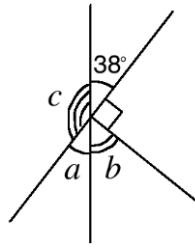

3. In the diagram, ABCD is a rectangle. Find the measures of  $v$ ,  $w$ ,  $x$  and  $y$ :

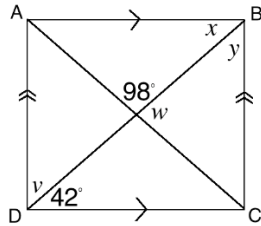



<b>Lesson Title:</b> Classification of triangles: Equilateral, isosceles, and scalene	<b>Theme:</b> Geometry
<b>Practice Activity:</b> PHM1-L131	<b>Class:</b> SSS 1

	<p><b>Learning Outcome</b> By the end of the lesson, you will be able to classify illustrated triangles by their characteristics.</p>
---	---

**Overview**

**Scalene triangles** are triangle with three sides of different lengths.

- When sides of a triangle are equal in length, we call them “congruent”. A scalene triangle has no congruent sides.
- All the angles of a scalene triangle have different measures.

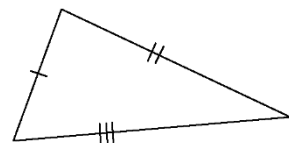

**Isosceles triangles** have 2 sides equal. Two angles are also equal.

- The two equal sides can be called “congruent”.
- No matter which direction the triangles’ apex, or peak, points, it’s an isosceles triangle if two of its sides are equal.

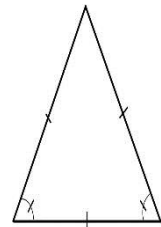

**Equilateral triangles** have three sides and three angles that are equal, or congruent.

- The angles of an equilateral triangle are always 60°.

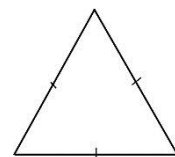

**Solved Examples**

1. Classify each triangle as equilateral, scalene or isosceles by its sides. Give your reasons.

a.

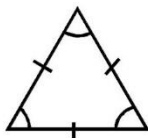

b.

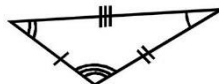

c.

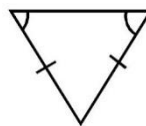

d.

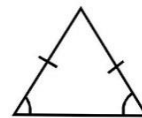

**Solutions:**

- Equilateral triangle: All three sides are equal.
- Scalene triangle: None of the sides are equal.
- Isosceles triangle: Two adjacent sides are equal.
- Isosceles triangle: Two adjacent sides are equal.

2. Classify each triangle as equilateral, scalene or isosceles by its angles. Give your reasons.

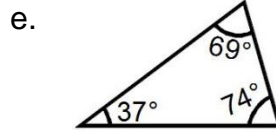
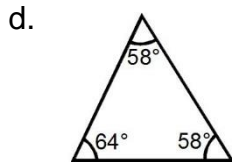
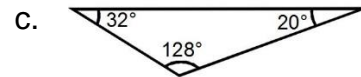
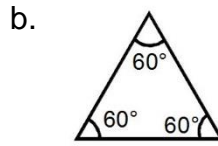
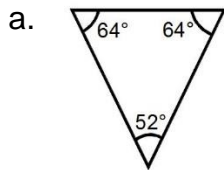

**Solutions:**

- a. Isosceles triangle: Two angles are equal.
- b. Equilateral triangle: All 3 angles are equal.
- c. Scalene triangle: All 3 angles are different.
- d. Isosceles triangle: Two angles are equal.
- e. Scalene triangle: All 3 angles are different.

3. Identify the type of triangle as equilateral, scalene or isosceles based on the following information. Give your reasons.

- a. A triangle with sides 5cm, 3cm, 4cm.
- b. A triangle with all sides and angles equal.
- c. A triangle with angles  $70^\circ$ ,  $40^\circ$ ,  $70^\circ$ .
- d. A triangle with angles  $108^\circ$ ,  $32^\circ$ ,  $40^\circ$ .
- e. A triangle with two sides equal and the corresponding base angles equal.

**Solutions:**

- a. Scalene triangle: All 3 sides are have different lengths.
- b. Equilateral triangle: All sides are equal, and all angles are equal.
- c. Isosceles triangle: Two angles have equal measure.
- d. Scalene triangle: All 3 angles have different measures.
- e. Isosceles triangle: Two angle are equal, and 2 sides are equal.

**Practice**

1. Classify each triangle as equilateral, scalene, or isosceles by its angles.

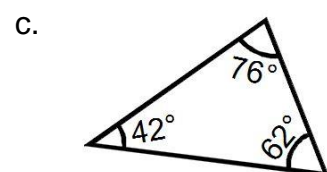
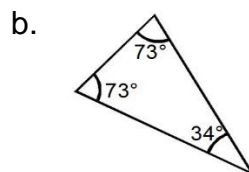
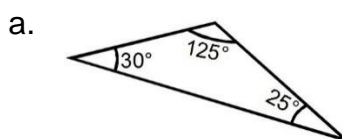

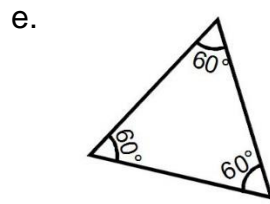
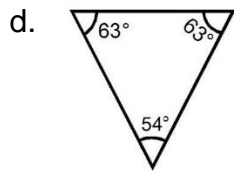

2. Identify the type of triangle as equilateral, scalene or isosceles based on the information given.

- a. A triangle with sides 12cm, 8cm, 5cm.
- b. A triangle with all sides and angles different.
- c. A triangle with angles  $65^\circ, 50^\circ, 65^\circ$ .
- d. A triangle with all angles equal and all sides equal.
- e. A triangle with two sides equal.

<b>Lesson Title:</b> Drawing of triangles	<b>Theme:</b> Geometry
<b>Practice Activity:</b> PHM1-L132	<b>Class:</b> SSS 1



### Learning Outcome

By the end of the lesson, you will be able to draw triangles based on numerical data.

### Overview

Triangles can be drawn using the measures of their sides and angles. We only need three specific details about the triangle to draw it. Triangles can be drawn accurately using only 2 angles and the line connecting them. We use a protractor and ruler to draw an accurate triangle. When you are given measurements for two angles and one side, always start with the given side.

### Solved Examples

1. Draw accurately the following triangles given their properties and identify them as equilateral, isosceles or scalene triangle triangles.
  - a.  $\triangle ABC$  such that  $\angle A = 70^\circ$ ,  $\angle B = 50^\circ$  and  $|AB| = 90$  mm
  - b.  $\triangle EFG$  such that  $|EF| = |FG| = |GE| = 65$  mm
  - c.  $\triangle ABC$  such that  $\angle A = 90^\circ$ ,  $|AB| = 6$  cm and  $\angle B = 40^\circ$

#### Solutions:

- a. Step 1: Draw line  $|AB| = 90$  mm in length. (Note that 90 mm = 9 cm)  
Step 2: With protractor at A, measure  $70^\circ$  anticlockwise and draw a line.  
Step 3: With protractor at B, measure  $50^\circ$  clockwise and draw a line.  
Step 3: Label the point of intersection of the 2 lines as C.

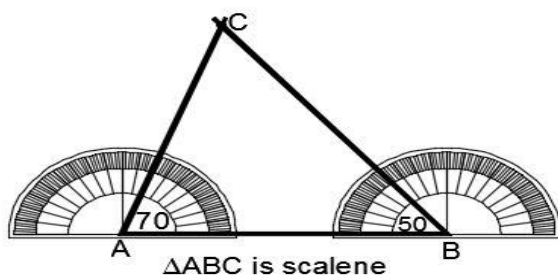

- b. To draw equilateral triangle EFG using a pair of compasses:
  - Step 1: Measure and draw line  $|EF| = 65$  mm
  - Step 2: Open your compass to a radius  $|FG| = |GE| = 65$  mm. Put compass point E and cut an arc at above  $|EF|$ . Maintaining the radius put the compass point at F and cut another arc above  $|EF|$  to cut the first arc at G.
  - Step 3: Draw lines through G to E and F to get  $\triangle EFG$ .

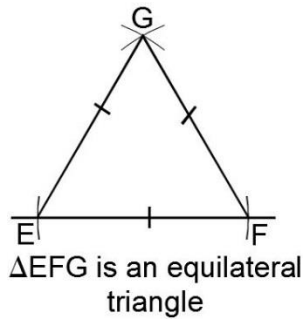

Alternatively, you may draw EFG using the fact that an equilateral triangle has angles of  $60^\circ$ . Draw the base line EF, and draw  $60^\circ$  angles at both E and F. The lines meet at point G and form an equilateral triangle.

- c. Step 1: Measure and draw line  $|AB| = 6$  cm  
 Step 2: Construct a perpendicular at point A on  $|AB|$  using a protractor or pair of compasses.  
 Step 3: Using a protractor with its centre at B measure clockwise  $\angle B = 50^\circ$   
 Step 4: Draw line through angle measure on protractor to meet the perpendicular line at C.

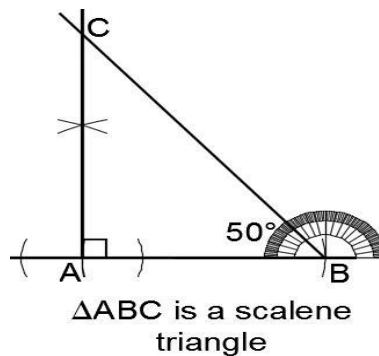

### Practice

Accurately draw the following triangles given their properties as follows. Also identify each triangle as equilateral, isosceles or scalene.

1.  $\triangle BCD$  such that  $\angle B = 75^\circ$ ,  $\angle C = 45^\circ$  and  $|BC| = 80$  mm
2.  $\triangle FGH$  such that  $|FG| = |GH| = |HF| = 60$  mm
3.  $\triangle VWX$  such that  $|VW| = 65$  mm and  $\angle V = \angle W = 45^\circ$

<b>Lesson Title:</b> Interior and exterior angles of a triangle	<b>Theme:</b> Geometry
<b>Practice Activity:</b> PHM1-L133	<b>Class:</b> SSS 1



### Learning Outcome

By the end of the lesson, you will be able to calculate the measurements of interior and exterior angles of a triangle.

### Overview

In the triangle below, the angles  $a$ ,  $b$ , and  $c$  are called **interior** angles. An interior angle is an angle inside a shape. The sum of the interior angles is equal to  $180^\circ$ .

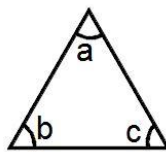

In the triangle below, the angles  $a$ ,  $b$  and  $c$  are called **exterior** angles. The exterior angles of a triangle are supplementary to the interior angles. They are formed by extending the sides of a triangle. The sum of the exterior angles is equal to  $360^\circ$ .

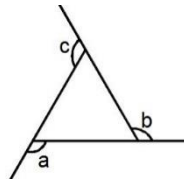

The exterior angle of a triangle is equal to the sum of the two opposite interior angles. In the diagram below,  $\angle a + \angle b = \angle c$ .

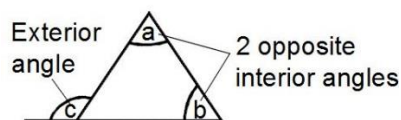

### Solved Examples

1. Find the size of the angle marked  $x$  in the triangle below:

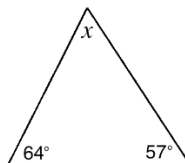

#### Solution:

The sum of the interior angles of a triangle is  $180^\circ$ .

$$x + 64^\circ + 57^\circ = 180^\circ$$

$$x + 121^\circ = 180^\circ$$

$$x = 180^\circ - 121^\circ$$

$$x = 59^\circ$$

2. Find the value of  $m$  in the diagram below:

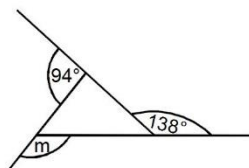

**Solution:**

The sum of the exterior angles of a triangle is  $360^\circ$ .

$$m + 94^\circ + 138^\circ = 360^\circ$$

$$m + 232^\circ = 360^\circ$$

$$m = 360^\circ - 232^\circ$$

$$m = 128^\circ$$

3. Find the size of angles  $p$  and  $q$  in the triangle below:

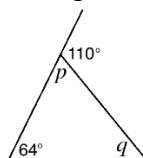

**Solution:**

$p$  and  $110^\circ$  are adjacent and supplementary. Therefore:

$$p + 110^\circ = 180^\circ$$

$$p = 180^\circ - 110^\circ$$

$$p = 70^\circ$$

The sum of the opposite interior angles are equal to the exterior angle:

$$q + 64^\circ = 110^\circ$$

$$q = 110^\circ - 64^\circ$$

$$q = 46^\circ$$

4. Find the value of angles  $a$ ,  $b$  and  $c$  in the diagram below:

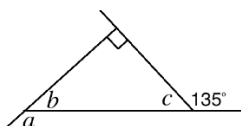

**Solution:**

Find  $a$  using the sum of the exterior angles:

$$a + 90^\circ + 135^\circ = 360^\circ$$

$$a + 225^\circ = 360^\circ$$

$$a = 360^\circ - 225^\circ$$

$$a = 135^\circ$$

$a$  and  $b$  are supplementary. Therefore  $b = 180^\circ - a = 180^\circ - 135^\circ = 45^\circ$ .

Find  $c$  using the sum of the interior angles of a triangle, or the fact that the sum of the opposite interior angles equals the exterior angles.

$$\begin{aligned} b + c &= 90^\circ \\ 45^\circ + c &= 90^\circ \\ c &= 90^\circ - 45^\circ \\ c &= 45^\circ \end{aligned}$$

5. Find the value of  $x$  in the diagram below:

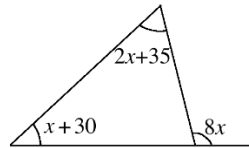

**Solution:**

Note that we have  $(x + 30)^\circ + (2x + 35)^\circ = (8x)^\circ$  because the sum of 2 interior angles is equal to the opposite exterior angle. Solve for  $x$ :

$$\begin{aligned} (x + 30)^\circ + (2x + 35)^\circ &= (8x)^\circ \\ x + 30 + 2x + 35 &= 8x \\ 65 + 3x &= 8x \\ 65 &= 8x - 3x = 5x \\ \frac{65}{5} &= x \\ 13 &= x \end{aligned}$$

### Practice

1. Find the value of the lettered angles in the diagrams below:

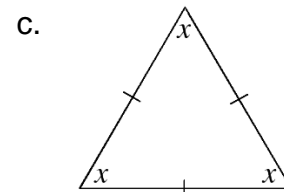
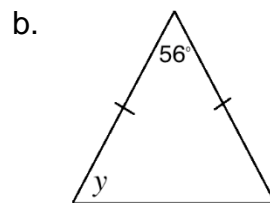
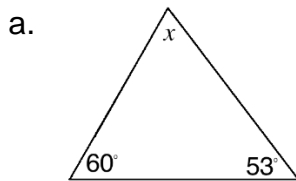

2. Find the value of  $y$  in the diagram below:

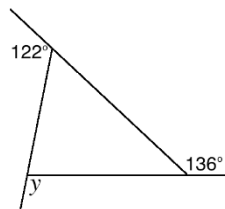

3. Find the value of  $x$  in the figure below:

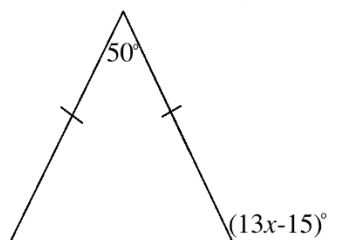



<b>Lesson Title:</b> Acute-, obtuse- and right-angled triangles	<b>Theme:</b> Geometry
<b>Practice Activity:</b> PHM1-L134	<b>Class:</b> SSS 1

	<p><b>Learning Outcomes</b></p> <p>By the end of the lesson, you will be able to:</p> <ol style="list-style-type: none"> <li>1. Identify characteristics of acute-, obtuse- and right-angled triangles.</li> <li>2. Classify triangles as acute, obtuse, or right.</li> </ol>
---	---

### Overview

This lesson is on 3 types of triangles: acute-angled, right-angled, and obtuse-angled. Their characteristics are given in the table below:

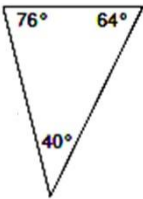
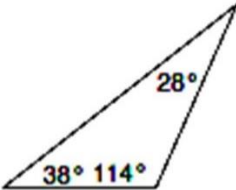
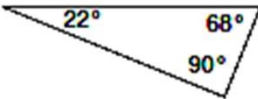
Triangle	Characteristics	Example
Acute-angled	All 3 angles less than $90^\circ$ .	
Obtuse-angled	Exactly 1 angle is more than $90^\circ$ .	
Right-angled	One angle is equal to $90^\circ$ . It can be marked with a square. The other two other angles are acute angles, and sum to $90^\circ$ . The longest side is called the hypotenuse.	

### Solved Examples

1. Classify each triangle as acute-, obtuse-, or right-angled based on its angles.

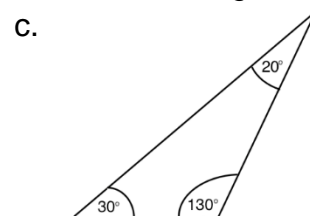
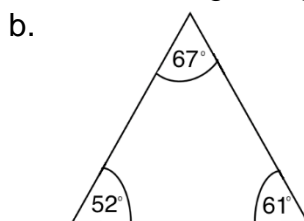
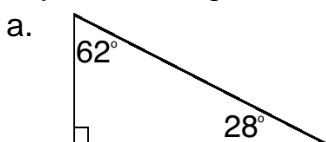

#### Solutions:

- Right-angled triangle, because one angle is  $90^\circ$ .
- Acute-angled triangle, because all the angles are less than  $90^\circ$ .
- Obtuse-angled triangle, because one of the angles is greater than  $90^\circ$ .

2. Identify the triangle based on the following information:

- a. A triangle with angles  $46^\circ, 72^\circ, 62^\circ$
- b. A triangle with angles  $33^\circ, 98^\circ, 49^\circ$
- c. A triangle with angles  $65^\circ, 90^\circ, 25^\circ$
- d. A triangle with angles  $56^\circ, 23^\circ, 101^\circ$
- e. A triangle with angles  $108^\circ, 36^\circ, 36^\circ$

**Solutions:**

- a. Acute-angled triangle, because all the angles are less than  $90^\circ$ .
- b. Obtuse-angled triangle, because one angle is greater than  $90^\circ$ .
- c. Right-angled triangle, because one angle is  $90^\circ$ .
- d. Obtuse-angled triangle, because one angle is greater than  $90^\circ$ .
- e. Acute-angled triangle, because all the angles are less than  $90^\circ$ .

**Practice**

1. Classify each triangle as acute-, obtuse- or right-angled.

a.

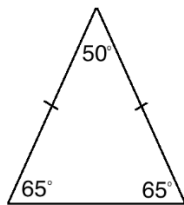

b.

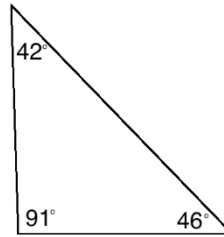

c.

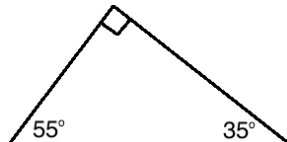

d.

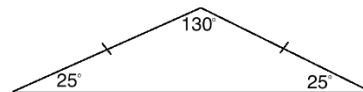

2. Identify the type of triangle based on the following information:

- a. One angle is exactly  $90^\circ$ .
- b. All the angles are less than  $90^\circ$ .
- c. It has angles  $40^\circ, 115^\circ, 25^\circ$ .
- d. It has angles  $23^\circ, 84^\circ, 73^\circ$ .
- e. One of the angles is greater than  $90^\circ$ .
- f. It has angles  $48^\circ, 90^\circ, 42^\circ$ .

<b>Lesson Title:</b> Congruent and similar triangles	<b>Theme:</b> Geometry
<b>Practice Activity:</b> PHM1-L135	<b>Class:</b> SSS 1

 <b>Learning Outcome</b> By the end of the lesson, you will be able to classify triangles as similar or congruent.
--

## Overview

**Similar triangles** have the same shape, but are of different size. All of their angles are equal, but the sides are of different lengths. In the diagrams below,  $\angle B = \angle E$ ,  $\angle C = \angle F$ , and  $\angle A = \angle D$ .



For any pair of similar shapes, the corresponding sides are in the same ratio and corresponding angles are equal. The sides of the above triangles can be written as ratios:  $\frac{|AB|}{|DE|} = \frac{|BC|}{|ED|} = \frac{|CA|}{|FD|}$ . These ratios can be used to solve for the sides of similar triangles (not covered in this lesson).

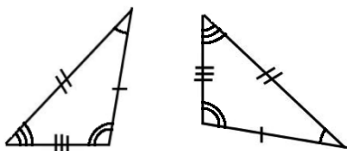

Congruent shapes have exactly the same shape and size. The two triangles below are **congruent**. Although at first sight they may appear different, they are exactly the same.

If one of these triangles were rotated and moved, it could be arranged to fit exactly over the other. A triangle can be translated (moved), rotated, or flipped, and the result is still a congruent triangle.

When naming congruent triangles, give the letters in the correct order so that it is clear which letters of the triangles correspond to each other. Use the symbol  $\equiv$  to mean “is identically equal to” or “is congruent to”. For example,  $\triangle DEF \equiv \triangle KJL$  means that triangles  $DEF$  and  $KJL$  are congruent; angle  $D$  corresponds to angle  $K$ , and so on.

We identify whether triangles are congruent based on their sides and angles. Two triangles are congruent if:

- Two sides and the included angle of one are respectively equal to two sides and the included angle of the other (SAS).

- Two angles and a side of one are respectively equal to two angles and the corresponding side of the other (ASA or AAS).
- The three sides of one are respectively equal to the three sides of the other (SSS).
- They are right-angled, and have the hypotenuse and another side of one respectively equal to the hypotenuse and another side of the other (RHS).

### Solved Examples

1. Given the following similar triangles, identify the equal angles and the corresponding sides.

a.

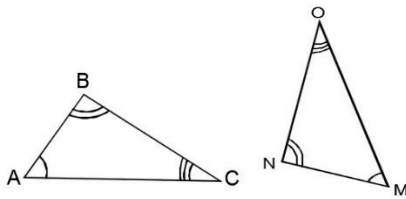

b.

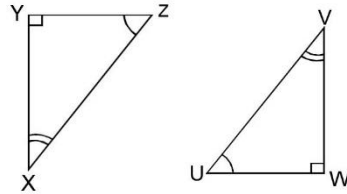

#### Solutions:

a.  $\angle A = \angle M$ ,  $\angle B = \angle N$ ,  $\angle C = \angle O$

$|BC|$  corresponds to  $|NO|$ ;  $|AC|$  corresponds to  $|OM|$ ;  $|AB|$  corresponds to  $|MN|$

ii.  $\angle Y = \angle W$ ,  $\angle Z = \angle U$ ,  $\angle X = \angle V$

$|ZX|$  corresponds to  $|UV|$ ;  $|XY|$  corresponds to  $|VW|$ ;  $|YZ|$  corresponds to  $|WU|$

2. From the similar triangles shown below, write the ratios of corresponding sides.

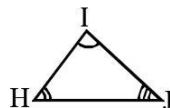
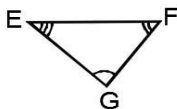

#### Solution:

The ratios are  $\frac{|EF|}{|JH|} = \frac{|GE|}{|IJ|} = \frac{FG}{HI}$ .

3. Identify the similar triangles in the figure below, and give your reasons.

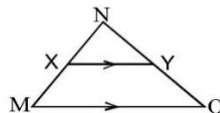

#### Solution:

$\triangle MNO$  is similar to  $\triangle XNY$ . We know this because all 3 angles of these triangles are equal. Note that  $\angle NMO = \angle NXY$  because these are corresponding angles. For the same reason,  $\angle NOM = \angle NYX$ .

4. Establish whether each pair of triangles are congruent or not.

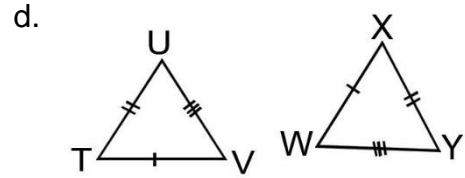
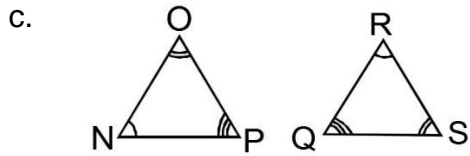
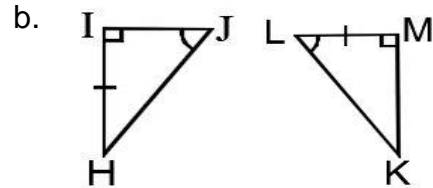
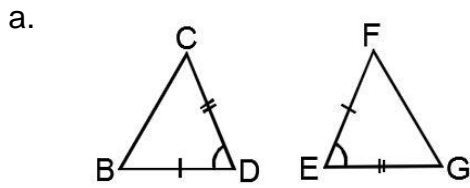

**Solutions:**

a. In  $\triangle BCD$  and  $\triangle EFG$   
 $|DB| = |EF|$  (equal sides S)  
 $|CD| = |GE|$  (equal side S)  
 And  $\angle D = \angle E$  (equal angles A)  
 Hence  $\triangle BCD$  and  $\triangle EFG$  are **congruent** (side angle side, SAS)

b. In  $\triangle HIJ$  and  $\triangle LMK$   
 $\angle I = \angle M$  (equal angles A)  
 $\angle J = \angle L$  (equal angles A)  
 $|HI| = |LM|$  (equal side S)  
 Hence  $\triangle HIJ$  and  $\triangle LMK$  are **congruent** (AAS or ASA)

c. In  $\triangle NOP$  and  $\triangle QRS$   
 $\angle N = \angle R$  (equal angles A)  
 $\angle O = \angle S$  (equal angles A)  
 $\angle P = \angle Q$  (equal angles A)  
 There is **not enough information** to identify if  $\triangle NOP$  and  $\triangle QRS$  are congruent.

d. In  $\triangle TUV$  and  $\triangle WXY$   
 $|VT| = |WX|$  (equal sides S)  
 $|TU| = |XY|$  (equal side S)  
 $|UV| = |YW|$  (equal side S)  
 $\triangle BCD$  and  $\triangle EFG$  are **congruent** (SSS)

**Practice**

1. Establish whether the triangles below are similar and explain why.

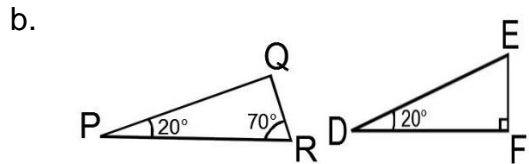
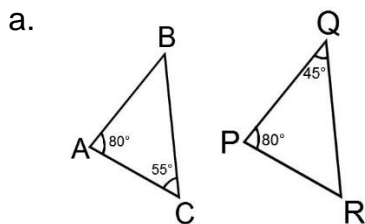

2. For the similar triangles shown below, write the ratio of corresponding sides



3. a. Identify the two triangles in the figure to the right.  
 b. State whether the triangles identified in a. above are congruent or not, and justify your answer.

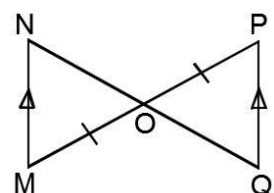

<b>Lesson Title:</b> Area of triangles	<b>Theme:</b> Geometry
<b>Practice Activity:</b> PHM1-L136	<b>Class:</b> SSS 1



### Learning Outcomes

By the end of the lesson, you will be able to:

1. Calculate the area of a triangle given the base and the height.
2. Calculate the area given the three sides.

### Overview

This lesson introduces 2 formulae for finding the area of a triangle.

The first formula is:  $\text{Area of a triangle} = \frac{1}{2} \text{ base} \times \text{height} = \frac{1}{2} bh$

This formula only requires 2 values: base and height. Base and height are always perpendicular to each other. You can take any side of the triangle as its base. Then you can find the height of the triangle from that base. The height is a perpendicular line drawn from the base to the opposite angle.

You can also calculate the area of a triangle if you know the length of all three sides.

This formula is called “Heron’s Formula” or “Hero’s Formula” after Hero of

Alexandria:  $\text{Area of a triangle} = \sqrt{s(s-a)(s-b)(s-c)}$ , where  $a, b, c$  are the lengths of the sides, and  $s = \frac{a+b+c}{2}$

### Solved Examples

1. Find the area of the triangle below:

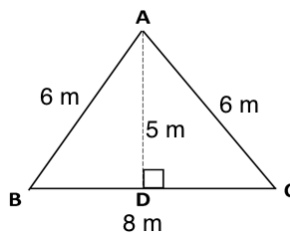

#### Solution:

In triangle ABC, length BC is the base and line AD is the perpendicular height of the triangle.

$$\begin{aligned}
 \text{Area} &= \frac{1}{2} \times \text{base} \times \text{height} \\
 &= \frac{1}{2} \times b \times h \\
 &= \frac{1}{2} \times 8 \text{ m} \times 5 \text{ m} \\
 &= 4 \text{ m} \times 5 \text{ m} \\
 &= 20 \text{ m}^2
 \end{aligned}$$

Note that area is always given in square units.

2. Find the area of the triangle below:

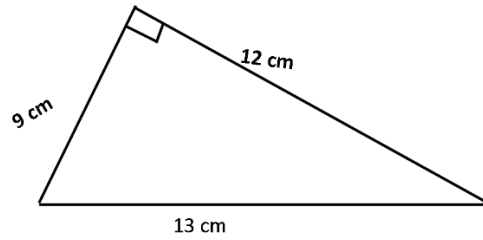

**Solution:**

$$\begin{aligned} \text{Base} &= 9 \text{ cm, height} = 12 \text{ cm} \\ \text{Area} &= \frac{1}{2} \times \text{base} \times \text{height} \\ &= \frac{1}{2} \times b \times h \\ &= \frac{1}{2} \times 9 \text{ cm} \times 12 \text{ cm} \\ &= 9 \text{ cm} \times 6 \text{ cm} \\ &= 54 \text{ cm}^2 \end{aligned}$$

3. Find the area of the triangle below. Give your answer to 1 decimal place.

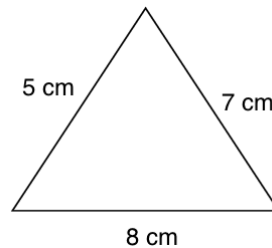

**Solution:**

When the three sides of a triangle are given, we use Heron's formula to calculate the area:

$$\text{Area of triangle} = \sqrt{s(s-a)(s-b)(s-c)}, \text{ where } s = \frac{a+b+c}{2}$$

$$\text{Let } a = 8 \text{ cm, } b = 7 \text{ cm, } c = 5 \text{ cm}$$

$$\text{Step 1. Find } s: s = \frac{8 \text{ cm} + 7 \text{ cm} + 5 \text{ cm}}{2} = \frac{20 \text{ cm}}{2} = 10 \text{ cm}$$

**Step 2.** Substitute and calculate area:

$$\begin{aligned} \text{Area} &= \sqrt{10(10-8)(10-7)(10-5)} \\ &= \sqrt{10(2)(3)(5)} \\ &= \sqrt{300} \\ &= 17.3 \text{ cm}^2 \end{aligned}$$

4. Find the area of an isosceles triangle of base 5 m, where the other two sides 7 m long. Give your answer to 1 decimal place.

**Solution:**

$$\text{Let } a = 7 \text{ m, } b = 7 \text{ m, } c = 5 \text{ m}$$

$$\text{Then } s = \frac{a+b+c}{2} = \frac{7+7+5}{2} = \frac{19}{2} = 9.5 \text{ m}$$

$$\text{Area} = \sqrt{s(s-a)(s-b)(s-c)}$$

$$\begin{aligned}
 \text{Area} &= \sqrt{9.5(9.5 - 7)(9.5 - 7)(9.5 - 5)} \\
 &= \sqrt{9.5(2.5)(2.5)(4.5)} \\
 &= \sqrt{267.1875} \\
 &= 16.3 \text{ cm}^2
 \end{aligned}$$

### Practice

1. Find the area of the triangles below:

a.

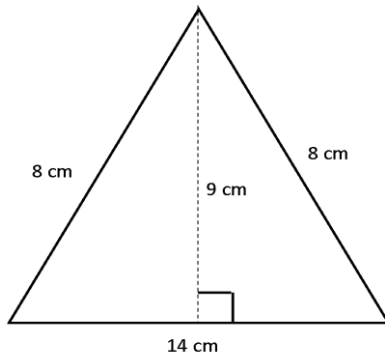

b.

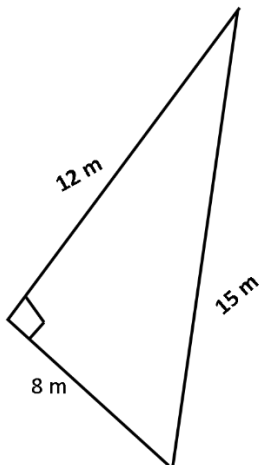

2. Find the area of a triangle of base 13 cm and height 18 cm.
3. Use Hero's formula to find the area of a triangle of length 11 cm, 10 cm and 9 cm.
4. Find the area of an equilateral triangle with sides of length 7 cm.



<b>Lesson Title:</b> Word problems involving triangles	<b>Theme:</b> Geometry
<b>Practice Activity:</b> PHM1-L137	<b>Class:</b> SSS 1

 <b>Learning Outcome</b> By the end of the lesson, you will be able to solve word problems involving triangles.
---

## Overview

This lesson is on solving problems involving triangles. Recall the following facts and formulae:

- Perimeter is the distance around a shape. It is calculated by adding the sides of a triangle.
- When the base and height of a triangle are given, calculate its area with the formula  $A = \frac{1}{2}bh$ .
- When the 3 sides of a triangle are given, calculate its area with the formula  $A = \sqrt{s(s-a)(s-b)(s-c)}$ , where  $s = \frac{a+b+c}{2}$ .

## Solved Examples

1. The area of a triangle is  $96 \text{ cm}^2$ . If its height is  $12 \text{ cm}$ , find the length of the base of the triangle.

### Solution:

Use the formula for area,  $A = \frac{1}{2}bh$ . Substitute the given values, and solve for  $b$ :

$$\begin{aligned}
 A &= \frac{1}{2}bh \\
 96 &= \frac{1}{2} \times b \times 12 \\
 2 \times 96 &= 12b \\
 192 &= 12b \\
 \frac{192}{12} &= \frac{12b}{12} \\
 16 \text{ cm} &= b
 \end{aligned}$$

2. The sides of a triangle are given as  $(2x) \text{ cm}$ ,  $(3x - 1) \text{ cm}$ , and  $(x + 5) \text{ cm}$ . If the perimeter of the triangle is  $64 \text{ cm}$ , find the area of the triangle. Give your answer to the nearest whole number.

### Solution:

Perimeter means distance round a plane shape. Set the sides equal to the perimeter and solve for  $x$ . Then, use  $x$  to find the lengths of the sides and the area.

$$\begin{aligned}
 P &= 2x + 3x - 1 + x + 5 \\
 64 &= 6x + 4 \\
 60 &= 6x \\
 \frac{60}{6} &= x \\
 10 &= x
 \end{aligned}$$

The three sides of the triangle are:

$$2x = 2 \times 10 = 20 \text{ cm}$$

$$3x - 1 = 3 \times 10 - 1 = 29 \text{ cm}$$

$$x + 5 = 10 + 5 = 15 \text{ cm}$$

Calculate the area of the triangle using Heron's formula:

Find  $s$ :  $s = \frac{a+b+c}{2} = \frac{20+29+15}{2} = \frac{64}{2} = 32$

Calculate area:

$$\begin{aligned}
 A &= \sqrt{s(s-a)(s-b)(s-c)} && \text{Heron's Formula} \\
 &= \sqrt{32(32-20)(32-29)(32-15)} \\
 &= \sqrt{32(12)(3)(17)} \\
 &= \sqrt{19584} \\
 &= 139.9 = 140 \text{ cm}^2
 \end{aligned}$$

3. Find the height of a right-angled triangle whose area is  $7.5 \text{ cm}^2$  and base is  $2.5 \text{ cm}$ .

**Solution:**

Substitute the given values in the area formula, and solve for  $h$ :

$$\begin{aligned}
 A &= \frac{1}{2}bh \\
 7.5 &= \frac{1}{2} \times 2.5 \times h \\
 2 \times 7.5 &= 2.5h \\
 15 &= 2.5h \\
 \frac{15}{2.5} &= h \\
 6 \text{ cm} &= h
 \end{aligned}$$

The height of the triangle is  $6 \text{ cm}$ .

4. Find the area of an equilateral triangle with sides of length  $30 \text{ cm}$ . Give your answer to the nearest whole number.

**Solution:**

First, draw a diagram:

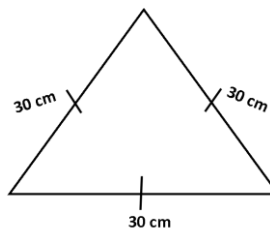

Find  $s$ :  $s = \frac{30+30+30}{3} = \frac{90}{3} = 45$

Apply Heron's formula:

$$\begin{aligned}
\text{Area} &= \sqrt{s(s-a)(s-b)(s-c)} \\
&= \sqrt{45(45-30)(45-30)(45-30)} \\
&= \sqrt{45(15)(15)(15)} \\
&= \sqrt{151875} \\
&= 389.7 \\
&= 390 \text{ cm}^2
\end{aligned}$$

### Practice

1. The area of a triangle is  $128.5 \text{ cm}^2$ . If its height is  $14.7 \text{ cm}$ , find the length of its base.
2. Find the height of a right-angled triangle whose area is  $15.8 \text{ cm}^2$  and base is  $4.6 \text{ cm}$ .
3. The sides of a triangle are given as  $(2x + 3) \text{ cm}$ ,  $(x + 3) \text{ cm}$ , and  $(2x - 1) \text{ cm}$ . If the perimeter of the triangle is  $85 \text{ cm}$ , calculate the area of the triangle.
4. Find the area of a triangle of base  $12 \text{ cm}$  and height  $11 \text{ cm}$ .
5. Find the height of a right-angled triangle of area  $150 \text{ cm}^2$  and base  $25 \text{ cm}$ .
6. The sides of a triangle are given as  $(x + 6) \text{ cm}$ ,  $(2x + 3) \text{ cm}$  and  $(x + 4) \text{ cm}$ . If the perimeter of the triangle is  $77 \text{ cm}$ , find the area of the triangle.

<b>Lesson Title:</b> Finding the hypotenuse of a right triangle	<b>Theme:</b> Geometry
<b>Practice Activity:</b> PHM1-L138	<b>Class:</b> SSS 1

 <b>Learning Outcome</b> By the end of the lesson, you will be able to find the hypotenuse of a right-angled triangle using Pythagoras' theorem.
--

## Overview

In Mathematics, the Pythagorean Theorem, also known as Pythagoras' theorem, is a relation among the three sides of a right triangle. It states that in a right-angled triangle, the square of the hypotenuse is equal to the sum of the squares of the other two sides. Recall that the longest side of the triangle is called the hypotenuse.

The general formula for Pythagoras' theorem is:

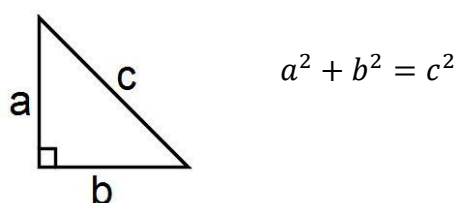

## Solved Examples

1. Find the value of  $x$  in the diagram below

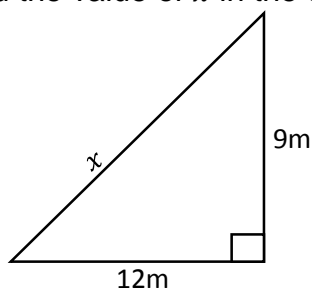

### Solution:

Using Pythagoras theorem  $c^2 = a^2 + b^2$ , where  $c$  is the length of the longest side in a right angle triangle and  $a$  and  $b$  are the other two sides.

$$\begin{aligned}
 x^2 &= 12^2 + 9^2 && \text{Substitute the value in the formula} \\
 &= 144 + 81 && \text{Simplify} \\
 &= 225 \\
 x &= \sqrt{225} && \text{Take the square root of both sides} \\
 &= 15\text{m}
 \end{aligned}$$

2. Find the values of  $y$  in the diagram below:

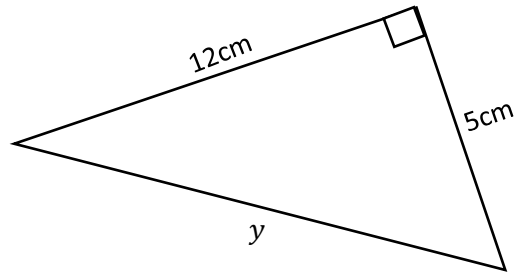

**Solution:**

$$\begin{aligned}y^2 &= 5^2 + 12^2 \\&= 25 + 144 \\&= 169 \\y &= \sqrt{169} \\&= 13 \text{ cm}\end{aligned}$$

3. Find the value of  $m$  in the diagram below:

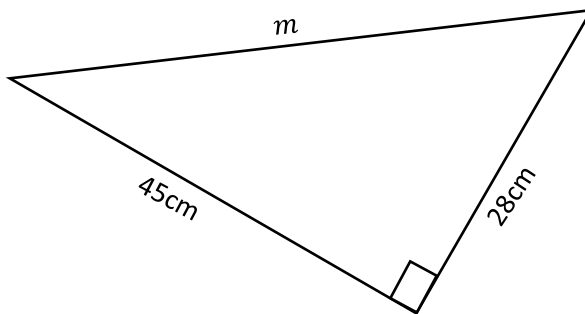

**Solution:**

$$\begin{aligned}m^2 &= 28^2 + 45^2 \\&= 784 + 2025 \\&= 2809 \\m &= \sqrt{2809} \\&= 53 \text{ cm}\end{aligned}$$

4. Calculate the length of line AD in the diagram below:

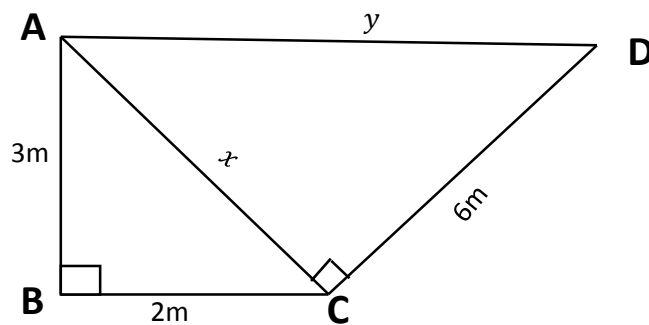

**Solution:**

In triangle ABC, AC is the longest side. In triangle ACD, AD is the longest side. Find the length of  $x$  using triangle ABC, then use it to find AD in triangle ACD.

In triangle ABC:

$$\begin{aligned}x^2 &= 3^2 + 2^2 \\ &= 9 + 4 \\ &= \sqrt{13}\end{aligned}$$

In triangle ACD:

$$\begin{aligned}y^2 &= x^2 + 6^2 \\ &= (\sqrt{13})^2 + 36 \\ &= 49\end{aligned}$$

$$\begin{aligned}y = |AD| &= \sqrt{49} \\ &= 7 \text{ cm}\end{aligned}$$

**Practice**

1. Calculate the length of the sides marked with letters in the following triangles:

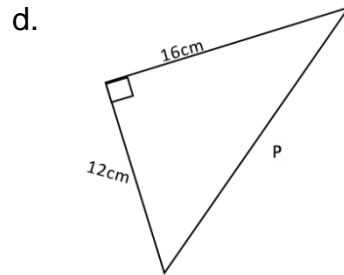
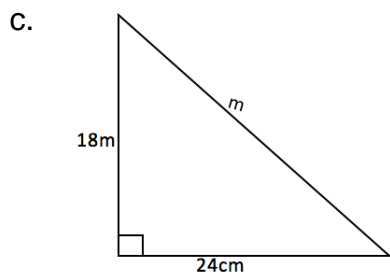
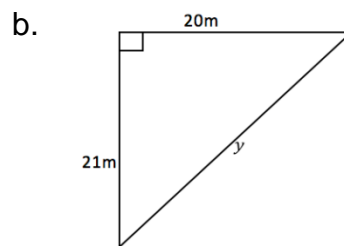
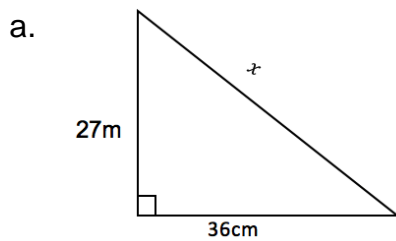

2. Calculate the length of PS in the diagram below:

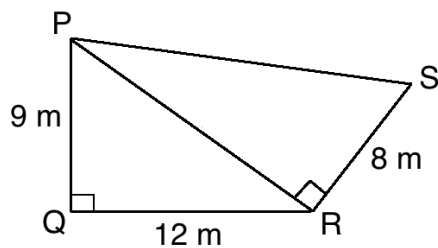

<b>Lesson Title:</b> Finding the other sides of a right-angled triangle	<b>Theme:</b> Geometry
<b>Practice Activity:</b> PHM1-L139	<b>Class:</b> SSS 1



### Learning Outcome

By the end of the lesson, you will be able to apply Pythagoras theorem to find the length of the other sides of a right-angled triangle/

### Overview

Recall that the hypotenuse is always opposite the right angle and it is always the longest side of the triangle. Pythagoras' Theorem can be used to find the third side of a right-angled triangle if the other two sides are known.

To find the sides  $a$  and  $b$ , change the subject of the formula for Pythagoras' theorem. Recall that the theorem is  $c^2 = a^2 + b^2$ .

From this, we can write the following:

- $a^2 = c^2 - b^2$  or  $a = \sqrt{c^2 - b^2}$
- $b^2 = c^2 - a^2$  or  $b = \sqrt{c^2 - a^2}$

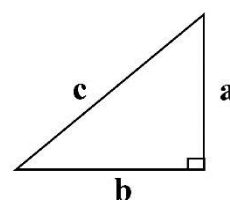

### Solved Examples

1. Find  $AB$  in the triangle below.

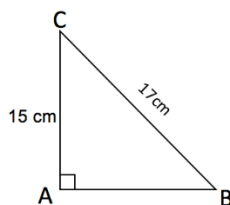

#### Solution:

Identify the known sides:  $|AC| = 15$  cm and  $|BC| = 17$  cm

$$|BC|^2 = |AC|^2 + |AB|^2 \quad \text{Pythagoras' theorem}$$

$$|AB|^2 = |BC|^2 - |AC|^2 \quad \text{Solve for } |AB|$$

$$= 17^2 - 15^2$$

$$= 289 - 225$$

$$= 64$$

$$AB = \sqrt{64} = 8 \text{ cm}$$

2. In triangle  $PQR$ ,  $|PQ| = |PR| = 5$  cm,  $|QR| = 6$  cm, and  $|QS| = |SR|$ . Find  $|PS|$ .

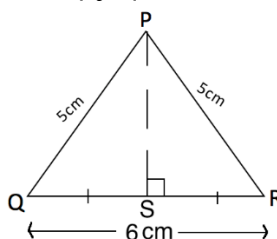

**Solution:**

Find the length of  $QS$  and  $SR$ , which can be used to find  $PS$ .

$$QS = SR = \frac{1}{2}QR = \frac{1}{2} \times 6 \text{ cm} = 3 \text{ cm}$$

In triangle PQS:

$$|PQ|^2 = |PS|^2 + |QS|^2$$

$$|PS|^2 = |PQ|^2 - |QS|^2$$

$$= 5^2 - 3^2$$

$$= 25 - 9$$

$$= 16$$

$$PS = \sqrt{16}$$

$$= 4$$

3. In the triangle below, calculate the length BC

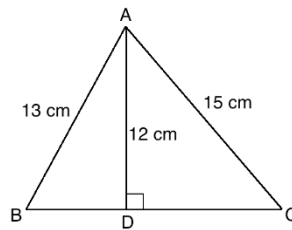
**Solution:**

Divide the shape into 2 triangles, ABD and ADC. Find the missing side of each triangle: BD and DC. Add the 2 lengths together to find BC.

$$|BC| = |BD| + |DC|$$

In triangle ABD:

$$|AB|^2 = |AD|^2 + |BD|^2$$

$$|BD|^2 = |AB|^2 - |AD|^2$$

$$= 13^2 - 12^2$$

$$= 169 - 144$$

$$= 25$$

$$|BD| = \sqrt{25}$$

$$BD = 5 \text{ cm}$$

In triangle ADC:

$$|AC|^2 = |AD|^2 + |DC|^2$$

$$|DC|^2 = |AC|^2 - |AD|^2$$

$$= 15^2 - 12^2$$

$$= 225 - 144$$

$$= 81$$

$$|DC| = \sqrt{81}$$

$$DC = 9 \text{ cm}$$

$$\text{Now, } BC = BD + DC$$

$$= 5 \text{ cm} + 9 \text{ cm}$$

$$= 14 \text{ cm}$$

4. Find the value of  $x$  in the figure below:

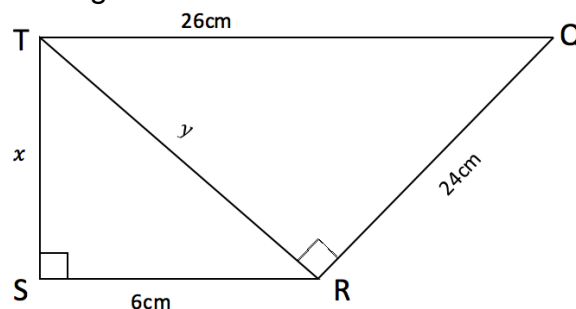



**Solution:**

Divide the shape into 2 triangles: TRQ and TSR. Use triangle TRQ to find the length of  $y$ . Then, use triangle TSR to find the length of  $x$ .

In triangle TRQ

$$\begin{aligned} 26^2 &= y^2 + 24^2 \\ y^2 &= 26^2 - 24^2 \\ &= 676 - 576 \\ &= 100 \\ &= \sqrt{100} \\ &= 10 \text{ cm} \end{aligned}$$

In triangle TSR

$$\begin{aligned} y^2 &= x^2 + 6^2 \\ x^2 &= y^2 - 6^2 \\ &= 100 - 36 \\ &= 64 \\ x &= \sqrt{64} \\ &= 8 \text{ cm} \end{aligned}$$

**Practice**

1. In the diagrams below, calculate the length of each side marked  $x$ .

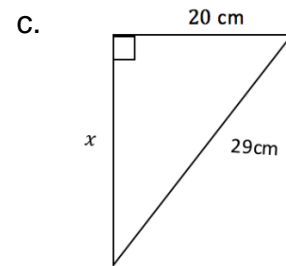
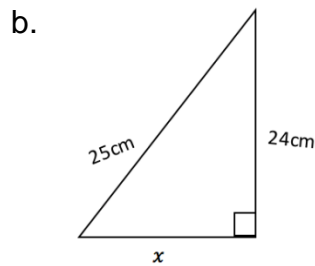
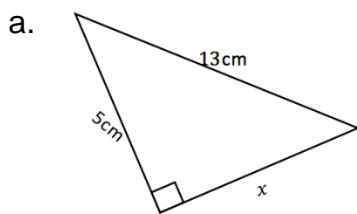

2. In the figure below, calculate the length of QS.

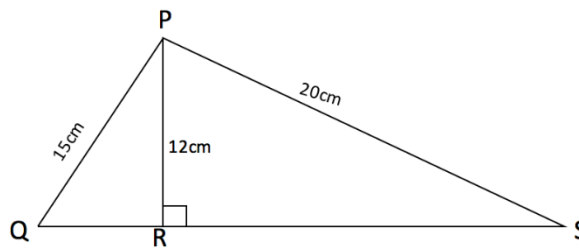

3. In the diagram below, calculate the length marked  $x$ .

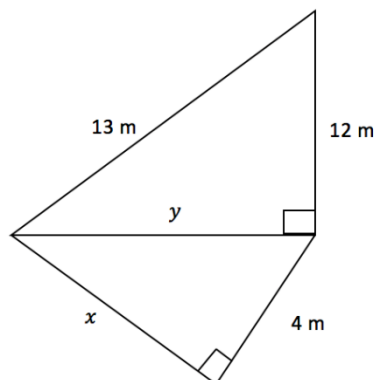

<b>Lesson Title:</b> Application of Pythagoras' Theorem	<b>Theme:</b> Geometry
<b>Practice Activity:</b> PHM1-L140	<b>Class:</b> SSS 1



### Learning Outcome

By the end of the lesson, you will be able to solve diagram and word problems involving Pythagoras' theorem.

### Overview

This lesson is on solving problems using Pythagoras' theorem. You may encounter word problems that require Pythagoras' theorem. It is very important to draw a diagram first to help with solving such problems.

### Solved Examples

1. Find the length of the diagonal of a rectangle with sides of length 12 cm and 18 cm. Give your answer to 1 decimal place.

**Solution:**

First, draw the rectangle showing its diagonal:

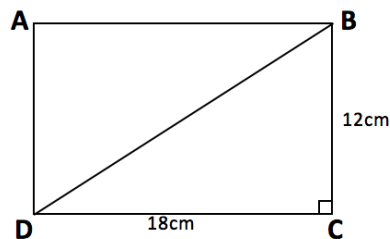

In rectangle ABCD, the diagonal is the hypotenuse of triangle ABD and BDC.

$$\begin{aligned}
 |BD|^2 &= 18^2 + 12^2 \\
 &= 324 + 144 \\
 BD &= \sqrt{468} \\
 BD &= 21.6 \text{ cm}
 \end{aligned}$$

2. One side of a rectangle is 7.2 cm and the diagonal is 17.4 cm. What is the length of the other side of the rectangle? Give your answer to one decimal place.

**Solution:**

First, draw a diagram:

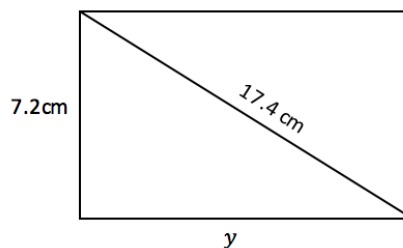

$$17.4^2 = 7.2^2 + y^2$$

$$\begin{aligned}
 y^2 &= 17.4^2 - 7.2^2 \\
 &= 302.76 - 51.84 \\
 &= 250.92 \\
 y &= \sqrt{250.90} \\
 &= 15.8 \text{ cm}
 \end{aligned}$$

3. A ladder 30 m long rests against a vertical wall. The distance between the foot of the ladder and the wall is 12 m. How far up the wall is the top of the ladder?

**Solution:**

First, draw a diagram:

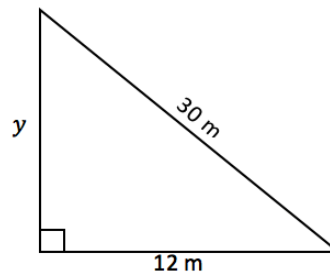
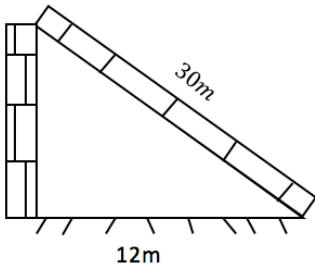

Use Pythagoras' theorem to find the height,  $y$ :

$$\begin{aligned}
 y^2 &= 30^2 - 12^2 \\
 &= 900 - 144 \\
 &= 746 \\
 y &= \sqrt{756} \\
 y &= 27.5 \text{ m}
 \end{aligned}$$

The top of the ladder is 27.5 metres from the ground.

4. The lengths of the sides of an equilateral triangle are 30 cm. Find the height of the triangle. Give your answer to the nearest whole number.

**Solution:**

First, draw a diagram:

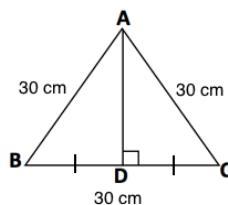

From the diagram, note that  $BD = \frac{1}{2} BC = \frac{30}{2} = 15$  cm. Use this to find  $|AD|$ :

$$\begin{aligned}
 |AD|^2 &= |AB|^2 - |BD|^2 \\
 &= 30^2 - 15^2 \\
 &= 900 - 225 \\
 &= 675 \\
 |AD| &= \sqrt{675} \\
 &= 25.98 = 26 \text{ cm}
 \end{aligned}$$

5. The foot of a ladder is 2 m from a wall and the top of the ladder is 6 m above the ground. Calculate the length of the ladder, correct to one decimal place.

**Solution:**

First, draw a diagram:

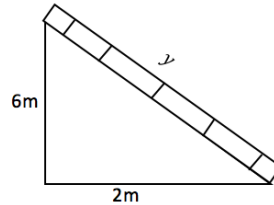

Apply Pythagoras' Theorem to find  $y$ :

$$\begin{aligned}y^2 &= 6^2 + 2^2 \\ &= 36 + 4 \\ &= 40 \\ y &= \sqrt{40} \\ &= 6.3 \text{ m}\end{aligned}$$

### Practice

1. One side of a rectangle is 6 cm and the diagonal is 8 cm. what is the length of the other side of the rectangle?
2. A ladder 9 m long leans against a wall. If the foot of the ladder is 4.5 m away from the wall, how far up the wall does the ladder reach?
3. The sides of an equilateral triangle are 8 cm long. Calculate the vertical height of the triangle.
4. The vertical height of an isosceles triangle is 8 cm. Find the third side if the length of the two equal sides are 12 cm.
5. A rectangular piece of cardboard is 40 cm long. The length of the diagonal is 50 cm. How wide is the cardboard?
6. A ladder leans against a vertical wall of height 15 m, if the foot of the ladder is 8 m away from the wall; calculate the length of the ladder.

### Answer Key – Term 3

<b>Lesson Title:</b> Rations and types of relations
<b>Practice Activity:</b> PHM1-L097

1. a.

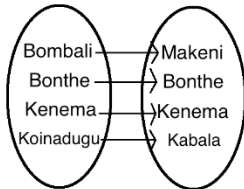

b.

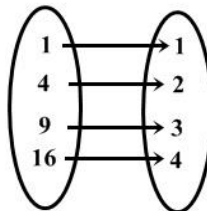

2. a. the relation is “square of”      b. One-to-one relation

3. a. Many-to-one      b. One-to-one      c. One-to-many

4. a. one-to-many      b. One-to-one

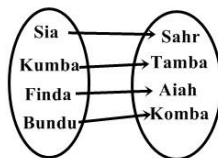
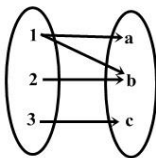

<b>Lesson Title:</b> Mapping including Domain and range
<b>Practice Activity:</b> PHM1-L098

- {a, b, c, d, e};
  - {f, g, h};
  - {f, g, h, i};
  - Range is subset of co-domain;
  - Relation is a mapping
- {a, b, c, p};
  - {d, e, f, g, r};
  - {d, e, f, g, r};
  - Range and co-domain are equal
  - Relation is a mapping.
- $y = 2x + 3$ ;
  - $y = 2^{x+3}$
- $p = 6$ ;
  - $p = 17$

<b>Lesson Title:</b> Functions Part 1
<b>Practice Activity:</b> PHM1-L099

- {2, 3, 6}

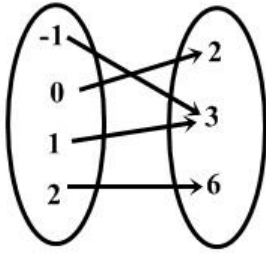

Not a one-to-one function

2. a. A function (every element in X has only one image in Y)

b. Not a function (element c in X has no image in Y)

c. A function (every element in X has one image in Y)

3. (i)  $w(t) = 3t - 5$  or  $w: t \rightarrow 3t - 5$  (ii)  $p(x) = 4x + 3$  or  $p: x \rightarrow 4x + 3$

(iii)  $g(x) = \frac{x^2-1}{x^2+1}$  or  $g: x \rightarrow \frac{x^2-1}{x^2+1}$  (iv)  $h(x) = \frac{2x-1}{2x+1}$  or  $h: x \rightarrow \frac{2x-1}{2x+1}$

4. (a)  $\{1\frac{1}{4}, 1, \frac{1}{2}, 1\}$  (b) (i)  $-\frac{1}{4}$  (ii) 5

**Lesson Title:** Functions- Part 2

**Practice Activity:** PHM1-L100

1. a. Not a function; b. A function

2. a. A function; b. Not a function; c. A function

3. a. A function; b. Not a function; c. Not a function

**Lesson Title:** Graphs of Linear functions

**Practice Activity:** PHM1-L101

1.

$x$	-3	-2	-1	0	1	2	3
$y$	-3	-1	1	3	5	7	9

2.

$x$	-4	-3	-2	-1	0	1	2
$y$	-18	-15	-12	-9	-6	-3	0

3.

$x$	-3	-2	-1	0	1	2	3
$y$	1	1.5	2	2.5	3	3.5	4

4.

$x$	-2	-1	0	1	2	3	4
$y$	7	5	3	1	-1	-3	-5

5.

$x$	-3	-2	-1	0	1	2	3
$y$	-1	1	3	5	7	9	11

**Lesson Title:** Graphs of linear functions

**Practice Activity:** PHM1-L102

1. Graph:

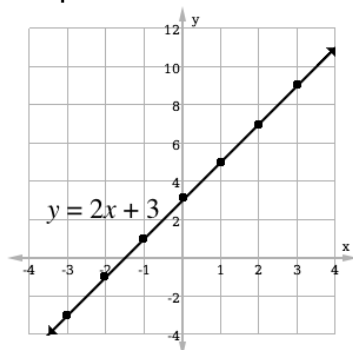

2. Graph:

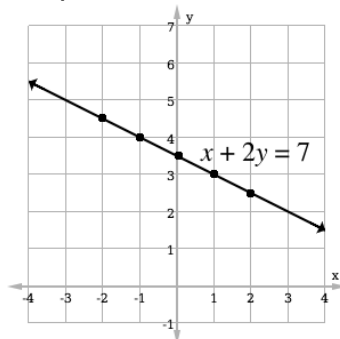

3. Table of values:

$x$	-2	-1	0	1	2	3
$y$	7	5	3	1	-1	-3

Graph:

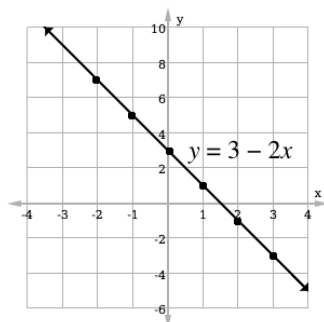

4. Table of values:

$x$	-3	-2	-1	0	1	2	3
$y$	-10	-7	-4	-1	2	5	8

Graph:

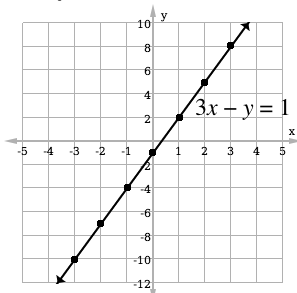

**Lesson Title:** Quadratic Functions

**Practice Activity:** PHM1-L103

1.

$x$	-3	-2	-1	0	1	2	3
$y$	34	17	6	1	2	9	22

2.

$x$	-2	-1	0	1	2	3
$y$	-1	4	5	2	-5	-16

3.

$x$	-2	-1	0	1	2	3
$y$	3	-2	-3	0	7	18

4.

$x$	-1	0	1	2	3	4
$y$	2	2	0	-4	-10	-18

5.

$x$	-3	-2	-1	0	1	2	3
$x^2$	9	4	1	0	1	4	9
$x$	-15	-10	-5	0	5	10	15
$-1$	-1	-1	-1	-1	-1	-1	-1
$y$	-7	-7	-5	-1	5	13	23



**Lesson Title:** Quadratic functions on the Cartesian Plane- Part 1

**Practice Activity:** PHM1-L104

1. Completed table of values:

$x$	-2	-1	0	1	2	3
$y$	15	5	1	3	11	25

Graph:

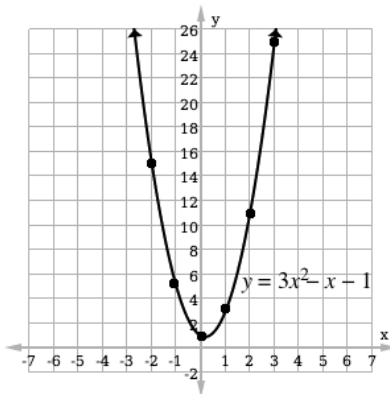

2. Graph:

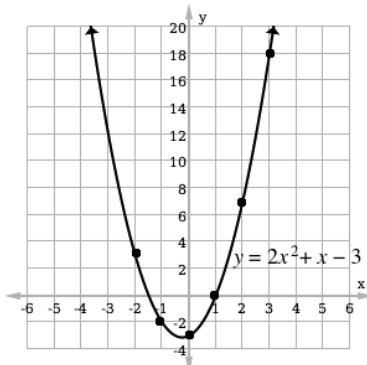

3. Table of values:

$x$	-2	-1	0	1	2
$y$	13	6	3	4	9

Graph:

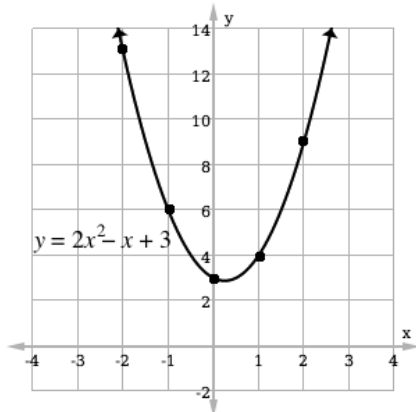

4. Graph:

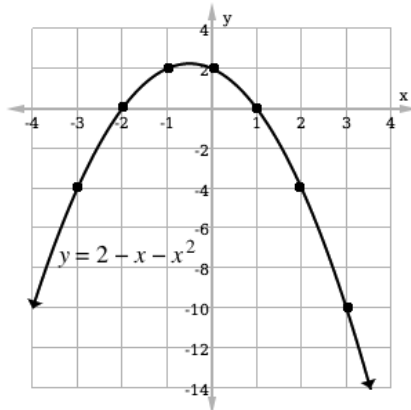

**Lesson Title:** Quadratic functions on the Cartesian plane-Part 2

**Practice Activity:** PHM1-L105

1. Graph:

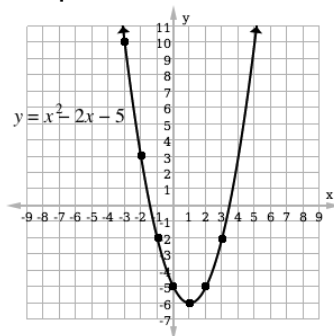

2. Graph:

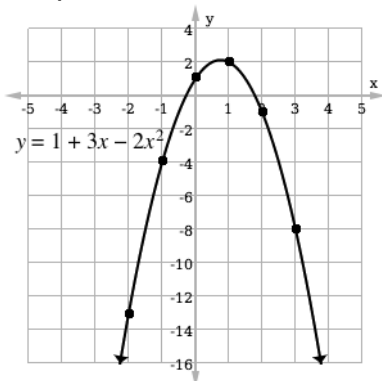

3. Table of values:

$x$	-3	-2	-1	0	1	2
$y$	2	0	0	2	6	12

Graph:

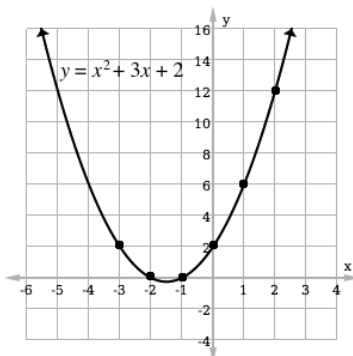

**Lesson Title:** Values from the graph of quadratic functions

**Practice Activity:** PHM1-L106

1. a. See table of values below; b. See graph below; c. i. Equation of the line of symmetry is  $x = -2.5$ ; ii. The coordinates of the minimum point are  $(-2.5, -2.3)$ , approximately.

$x$	-5	-4	-3	-2	-1	0
$y$	4	0	-2	-2	0	4

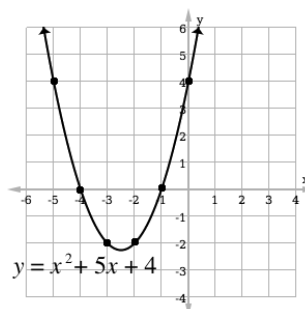

2. a. See table of values below; b. See graph below; c. i. Equation of the line of symmetry is  $x = -1.5$ ; ii. The coordinates of the maximum point are approximately  $(-1.5, 4.3)$ .

$x$	-4	-3	-2	-1	0	1
$y$	-2	2	4	4	2	-2

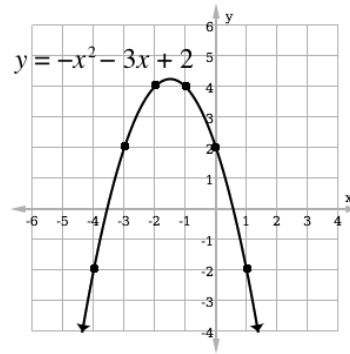

3. a. See table of values below; b. See graph below; c. Maximum:  $y = 7$

$x$	-3	-2	-1	0	1	2
$y$	-28	-5	6	5	-8	-33

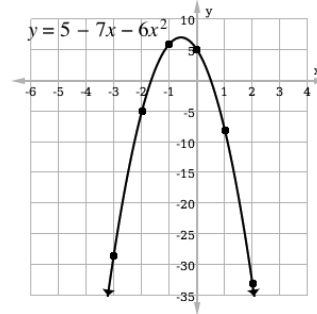

**Lesson Title:** Factorising Quadratic expressions

**Practice Activity:** PHM1-L107

- a.  $(x + 4)(x + 5)$ ; b.  $(p - 8)(p - 3)$ ; c.  $(y - 5)(y - 5)$ ; d.  $(n - 2)(n + 3)$
- $(x - 7)$
- $(u + 1)$

**Lesson Title:** Solving quadratic equation

**Practice Activity:** PHM1-L108

- $x = 0$
- $p = 0$  or  $p = -2$
- $x = 7$  or  $x = -2$ ,
- $y = 10$  or  $y = -3$ ,
- $x = 4$  twice
- $y = 6$  twice
- $x = 0$  or  $x = 12$

**Lesson Title:** Solving quadratic equations using factorisation

**Practice Activity:** PHM1-L109

1.  $y = -7$  or  $y = -2$
2.  $v = 1$  or  $v = 9$
3.  $x = -3$  or  $x = \frac{9}{2}$  or  $4\frac{1}{2}$
4.  $m = \frac{2}{5}$  or  $m = -\frac{5}{2}$  or  $-2\frac{1}{2}$
5.  $x = -1$  or  $x = \frac{10}{7}$  or  $1\frac{3}{7}$

**Lesson Title:** Finding a quadratic equation with given roots

**Practice Activity:** PHM1-L110

1.  $x^2 - 10x + 24 = 0$
2.  $x^2 + 9x + 14 = 0$
3.  $2x^2 - 3x - 27 = 0$
4.  $2x^2 - 3x - 2 = 0,$
5.  $15x^2 - 22x + 8 = 0$
6.  $7x^2 + 19x + 12 = 0$

**Lesson Title:** Graphical solution of quadratic equations

**Practice Activity:** PHM1-L111

1. See table of values below; a. see graph below; b. Roots:  $x = -1, 4$

$x$	-2	-1	0	1	2	3	4	5
$y$	6	0	-4	-6	-6	-4	0	6

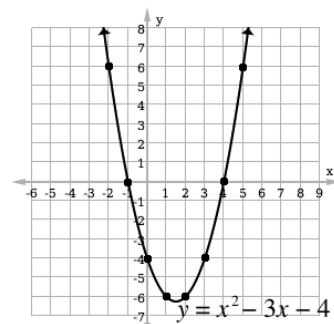

2. See table of values below; a. see graph below; b. Roots:  $x = 1, 2$

$x$	-2	-1	0	1	2	3	4	5
$y$	12	6	2	0	0	2	6	12

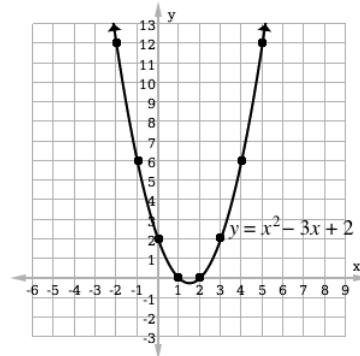

3. See completed table of values below; a. see graph below; b. Roots: approximately  $x = -1.7$  and  $0.5$ .

$x$	-3	-2	-1	0	1
$y$	-28	-5	6	5	-8

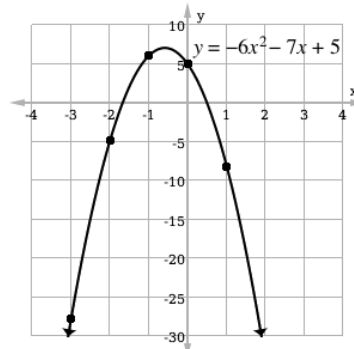

4. See completed table of values below; a. see graph below; b. Roots:  $x = -2$  and  $1$

$x$	-4	-3	-2	-1	0	1	2	3
$y$	10	4	0	-2	-2	0	4	10

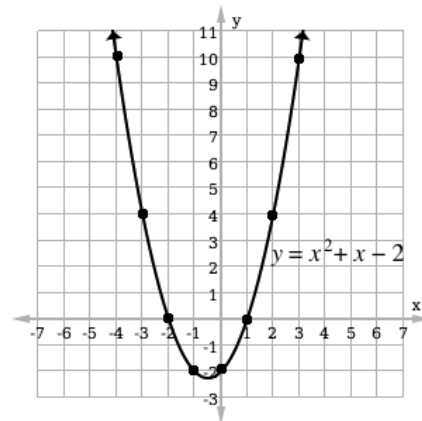

**Lesson Title:** Finding an equation from a given graph

**Practice Activity:** PHM1-L112

1. Roots:  $x = -2, 5$ ; Function:  $y = x^2 - 3x - 10$
2. Roots:  $x = -1.7, 1.2$  (approximately); Function:  $y = x^2 - 0.5x - 2.04$
3. Roots:  $x = 3, 4$ ; Function:  $y = x^2 - 7x + 12$

**Lesson Title:** Completing the square and perfect squares

**Practice Activity:** PHM1-L113

1.  $\frac{4+\sqrt{10}}{3}, \frac{4-\sqrt{10}}{3}$
2.  $\frac{5+\sqrt{11}}{2}, \frac{5-\sqrt{11}}{2}$
3. 1, -5
4. (a)  $-\frac{2}{3}, -\frac{3}{2}$  (b)  $\frac{-7+3\sqrt{7}}{4}, \frac{-7-3\sqrt{7}}{4}$  (c)  $\frac{1}{4}, -2$

**Lesson Title:** The quadratic formula

**Practice Activity:** PHM1-L114

1. -1, -11
2. 14, 2,
3. 6, -1,
4.  $\frac{3}{2}$  twice
5. -9, -12,
6.  $2, -\frac{4}{11},$
7.  $\frac{1}{2}, -1,$
8.  $\frac{1}{2}, -10,$
9.  $\frac{9}{4}, 2$

**Lesson Title:** Word problems leading to quadratic equations

**Practice Activity:** PHM1-L115

1.  $x = 8, y = 5$  or  $x = 11, y = 8$
2. 2, 11
3. 5 years
4. 24, 7
5. 9 cm, 18 cm

**Lesson Title:** Practice of quadratic equations

**Practice Activity:** PHM1-L116

1. a.  $\frac{3}{5}, 1$ ; b.  $3\frac{1}{3}, 1$
2. a. 7, -2; b. 7, 2
3. a.  $-1, -\frac{1}{2}$ ; b. -9, -12

4. Table of values:

$x$	-6	-5	-4	-3	-2	-1	0	1
$y$	10	4	0	-2	-2	0	4	10

Graph:

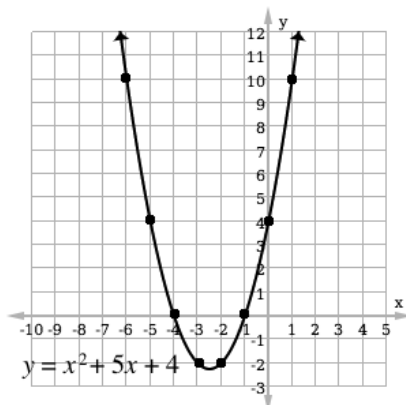

Solutions:  $x = -4, -1$

5.  $15x^2 - 22x + 8 = 0$

**Lesson Title:** The degree as a unit of measure

**Practice Activity:** PHM1-L117

- a. Two hundred and eighty degrees; b. Eighty point three nine degrees; c. Sixteen point five degrees.
- a.  $55^\circ$ ; b.  $66.5^\circ$ ; c.  $90.4^\circ$
- a.  $109^\circ$ ; b.  $162^\circ$ ; c.  $83^\circ$

**Lesson Title:** Acute, obtuse, right, reflex, and straight angles

**Practice Activity:** PHM1-L118

- a. Acute angle; b. Obtuse angle; c. Reflex angle; d. Reflex angle; e. reflex angle; f. obtuse angle.
- a.  $\angle XOY$  is an acute angle; b.  $\angle AOB$  is an obtuse angle; c.  $\angle MON$  is a straight angle; d.  $\angle QOP$  is an acute angle.



**Lesson Title:** Drawing of angles with specific measurements

**Practice Activity:** PHM1-L119

1.

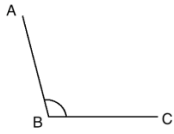

3.

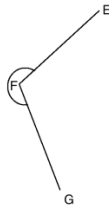

2.

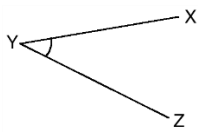

4.

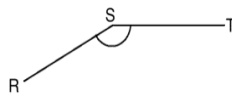

**Lesson Title:** Complementary and Supplementary angles

**Practice Activity:** PHM1-L120

1. a.  $56^\circ$  b.  $53^\circ$  c.  $60^\circ$  d.  $20^\circ$

2. a.  $70^\circ$  b.  $50^\circ$  c.  $105^\circ$  d.  $85^\circ$

3. a.  $50^\circ$  b.  $70^\circ$

4. a.  $49^\circ$  b.  $112^\circ$

5.  $35^\circ$

6.  $60^\circ$

**Lesson Title:** Parallel Lines

**Practice Activity:** PHM1-L121

1. Diagram:

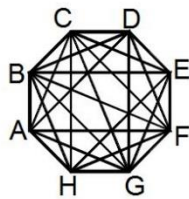

Sets of parallel segments:

$$\overline{AB} \parallel \overline{HC} \parallel \overline{GD} \parallel \overline{FE},$$

$$\begin{aligned} &\overline{CD} \parallel \overline{BE} \parallel \overline{AF} \parallel \overline{HG}, \\ &\overline{DE} \parallel \overline{CF} \parallel \overline{BG} \parallel \overline{AH}, \\ &\overline{GF} \parallel \overline{HE} \parallel \overline{AD} \parallel \overline{BD}, \\ &\overline{BD} \parallel \overline{AE} \parallel \overline{HF}, \\ &\overline{DF} \parallel \overline{CG} \parallel \overline{BH}, \\ &\overline{AC} \parallel \overline{AD} \parallel \overline{HE} \parallel \overline{GF} \\ &\overline{CE} \parallel \overline{BF} \parallel \overline{AG} \end{aligned}$$

2. Diagram:

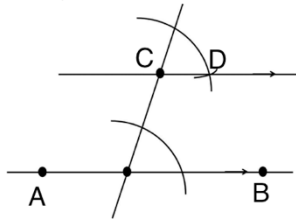

3. Diagram:

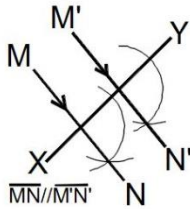

<b>Lesson Title:</b> Perpendicular Lines
<b>Practice Activity:</b> PHM1-L122

1.

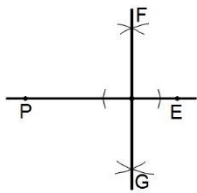

2.

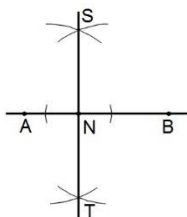

3.

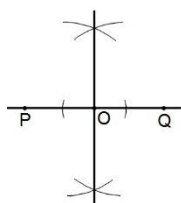

<b>Lesson Title:</b> Alternate and corresponding angles
---

<b>Practice Activity:</b> PHM1-L123
-------------------------------------

1. a.  $a = 112$  (Corresponding angles);  $b = 68$  (Corresponding angles); b.  $c = 68$  (Alternate angles); c.  $d = 45$  (Alternate angles);  $e = 30$  (Alternate angles)

2. a.  $p = 50$  (Alternate angles);  $q = 42$  (Alternate angles); b.  $u = 113$  (Corresponding angles)

<b>Lesson Title:</b> Adjacent and Opposite angles
---

<b>Practice Activity:</b> PHM1-L124
-------------------------------------

1. a.  $a = 93^\circ$ ;  $b = 87^\circ$ ;  $c = 93^\circ$ ; b.  $d = 60^\circ$

2. a.  $s = 75^\circ$   $r = 60^\circ$   $p = 75^\circ$   $q = 45^\circ$ ; b.  $t = 79^\circ$   $u = 79^\circ$

3. a.  $a = 54^\circ$   $b = 126^\circ$   $c = 105^\circ$   $d = 75^\circ$ ; b.  $e = 60^\circ$   $f = 110^\circ$

<b>Lesson Title:</b> Interior and exterior angles
---

<b>Practice Activity:</b> PHM1-L125
-------------------------------------

1. a. Interior angles:  $\angle l, \angle j$ ; Exterior angles:  $\angle m, \angle i, \angle k$

b. Interior angles:  $\angle x, \angle y$ ; Exterior angles:  $\angle w, \angle z$

2. a. Interior angles:  $70^\circ, 100^\circ, 140^\circ$ ; exterior angles:  $40^\circ, 110^\circ, 125^\circ$

b. Interior angles:  $50^\circ, 70^\circ, 60^\circ$ ; exterior angles:  $120^\circ, 130^\circ$

3. a. Interior angles:  $\angle c, \angle d, \angle f$ ; Exterior angles:  $\angle a, \angle b, \angle e$

b. Interior angles:  $\angle h, \angle i$ ; Exterior angles:  $\angle g$

<b>Lesson Title:</b> Practical application of angle measurement
---

<b>Practice Activity:</b> PHM1-L126
-------------------------------------

1. Approximately:  $\angle x = 44^\circ$ ,  $\angle y = 30^\circ$ ,  $\angle z = 44^\circ$ .

2. a.  $150^\circ$ , b.  $240^\circ$ ,

3. Approximately:  $\angle a = 45^\circ$ ,  $\angle b = 40^\circ$ ,  $\angle c = 55^\circ$ .

**Lesson Title:** Word problems involving angle measurement

**Practice Activity:** PHM1-L127

1.  $18^\circ$
2.  $90^\circ, 55^\circ, 35^\circ$
3.  $60^\circ, 30^\circ$

**Lesson Title:** Bisectors of angles and line segments

**Practice Activity:** PHM1-L128

1. a.  $\angle L = 90^\circ, \angle M = 60^\circ, \angle N = 30^\circ$ ; b. See diagram below:

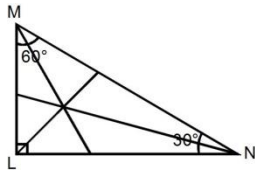

2. a. See diagram below; b. See diagram below; c.  $\angle ABD = 45^\circ, \angle CBD = 45^\circ$

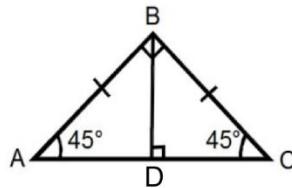

3. Diagram (not to scale):

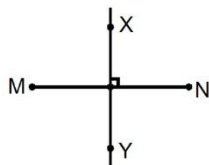

4. Diagram (not to scale):

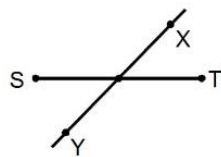

**Lesson Title:** Intercept Theorem

**Practice Activity:** PHM1-L129

1. a.  $y = 10.5$  cm; b.  $x = 3.3$  cm; c.  $y = 11.7$  cm

**Lesson Title:** Angle problem solving

**Practice Activity:** PHM1-L130

1.  $a = 140^\circ; b = 40^\circ; c = 40^\circ; d = 140^\circ$
2.  $a = 38^\circ; b = 52^\circ; c = 142^\circ;$
3.  $v = 48^\circ; w = 82^\circ; x = 42^\circ; y = 48^\circ$

**Lesson Title:** Classification of Triangles: Equilateral, Isosceles and Scalene

**Practice Activity:** PHM1-L131

1. a. Scalene triangle; b. Isosceles triangle; c. Scalene triangle; d. Isosceles triangle; e. Equilateral triangle
2. a. Scalene triangle; b. Scalene triangle; c. Isosceles triangle; d. equilateral triangle; e. Isosceles triangle

**Lesson Title:** Drawing of Triangles

**Practice Activity:** PHM1-L132

1.

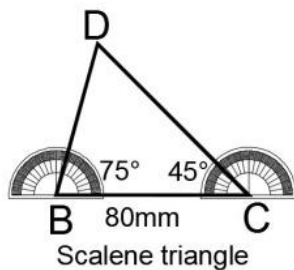

2.

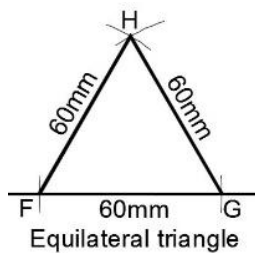

3.

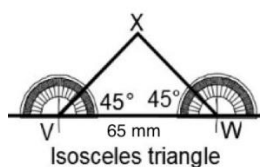

**Lesson Title:** Interior and Exterior angles of a triangle

**Practice Activity:** PHM1-L133

1. a.  $x = 67^\circ$    b.  $y = 62^\circ$    c.  $x = 60^\circ$
2.  $y = 102^\circ$
3.  $x = 10^\circ$

**Lesson Title:** Acute, Obtuse and right angle triangle

**Practice Activity:** PHM1-L134

1. a. Acute-angled; b. obtuse-angled; c. right-angled; d. obtuse-angled
2. a. right-angled; b. acute-angled; c. obtuse-angled; d. acute-angled; e. obtuse-angled; f. right-angled

**Lesson Title:** Congruent and similar triangles

**Practice Activity:** PHM1-L135

1. a. The triangles are similar, because all of the corresponding angles are equal.  $\angle A = \angle P = 80^\circ$ ,  $\angle C = \angle R = 55^\circ$ ,  $\angle B = \angle Q = 45^\circ$ ,  
b. The triangles are similar, because all of the corresponding angles are equal.  $\angle P = \angle D = 20^\circ$ ,  $\angle Q = \angle E = 70^\circ$ ,  $\angle R = \angle F = 90^\circ$
2.  $\frac{|PR|}{|DE|}$ ,  $\frac{|QR|}{|EF|}$ ,  $\frac{|PQ|}{|DF|}$
3. a.  $\triangle MNO$  and  $\triangle PQO$ ; b. The triangles are congruent (ASA).

**Lesson Title:** Area of triangles

**Practice Activity:** PHM1-L136

1. a.  $63 \text{ cm}^2$ ; b.  $48 \text{ m}^2$
2.  $117 \text{ cm}^2$
3.  $42.4 \text{ cm}^2$
4.  $21.2 \text{ cm}^2$

**Lesson Title:** Word problems involving triangles

**Practice Activity:** PHM1-L137

1. 17.5 cm
2. 6.9 cm
3.  $293.5 \text{ cm}^2$

4.  $66 \text{ cm}^2$
5. 12 cm
6.  $202.8 \text{ cm}^2$

<b>Lesson Title:</b> Finding the hypotenuse of a right triangle
---

<b>Practice Activity:</b> PHM1-L138
-------------------------------------

1. a. 45cm; b. 29cm; c. 30cm; d. 20cm
2. 17cm

<b>Lesson Title:</b> Finding the other sides of a right angle triangle
--

<b>Practice Activity:</b> PHM1-L139
-------------------------------------

1. a. 12 cm; b. 7 cm; c. 21 cm
2. 25 cm
3. 3 cm

<b>Lesson Title:</b> Application of Pythagorean's Theorem
---

<b>Practice Activity:</b> PHM1-L140
-------------------------------------

1. 5.3 cm
2. 7.8 m
3. 6.9 cm
4. 17.8 cm
5. 30 cm
6. 17 m

## Appendix I: Protractor

You can use a protractor to measure angles. If you do not have a protractor, you can make one with paper. Trace this protractor with a pen onto another piece of paper. Then, cut out the semi-circle using scissors.

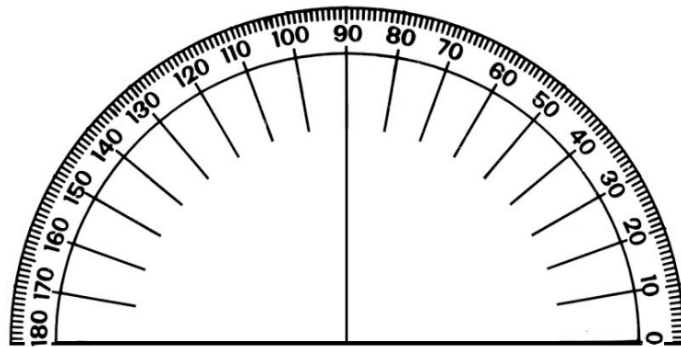



























**FUNDED BY**



**UKaid**  
from the British people

**IN PARTNERSHIP WITH**



NOT FOR SALE

Document information:

Leh Wi Learn (2018). *"Maths, SeniorSecondarySchool Year 1, Term 3, pupil hand-book."* A resource produced by the Sierra Leone Secondary Education Improvement Programme (SSEIP). DOI: 10.5281/zenodo.3745344.

Document available under Creative Commons Attribution 4.0,  
<https://creativecommons.org/licenses/by/4.0/>.

Uploaded by the EdTech Hub, <https://edtechhub.org>.

For more information, see <https://edtechhub.org/oer>.

Archived on Zenodo: April 2020.

DOI: 10.5281/zenodo.3745344

Please attribute this document as follows:

Leh Wi Learn (2018). *"Maths, SeniorSecondarySchool Year 1, Term 3, pupil hand-book."* A resource produced by the Sierra Leone Secondary Education Improvement Programme (SSEIP). DOI 10.5281/zenodo.3745344. Available under Creative Commons Attribution 4.0 (<https://creativecommons.org/licenses/by/4.0/>). A Global Public Good hosted by the EdTech Hub, <https://edtechhub.org>. For more information, see <https://edtechhub.org/oer>.